

SAMSUNG

SM-T310

User Manual

www.samsung.com

About this manual

This device provides high quality mobile communication and entertainment using Samsung's high standards and technological expertise. This user manual is specially designed to detail the device's functions and features.

- Please read this manual before using the device to ensure safe and proper use.
- Descriptions are based on the device's default settings.
- Images and screenshots may differ in appearance from the actual product.
- Content may differ from the final product, or from software provided by service providers or carriers, and is subject to change without prior notice. For the latest version of the manual, refer to the Samsung website, www.samsung.com.
- Content (high quality content) that requires high CPU and RAM usage will affect the overall performance of the device. Applications related to the content may not work properly depending on the device's specifications and the environment that it is used in.
- Available features and additional services may vary by device, software, or service provider.
- Applications and their functions may vary by country, region, or hardware specifications. Samsung is not liable for performance issues caused by applications from any provider other than Samsung.
- Samsung is not liable for performance issues or incompatibilities caused by edited registry settings or modified operating system software. Attempting to customise the operating system may cause the device or applications to work improperly.
- Software, sound sources, wallpapers, images, and other media provided with this device are licensed for limited use. Extracting and using these materials for commercial or other purposes is an infringement of copyright laws. Users are entirely responsible for illegal use of media.

- Default applications that come with the device are subject to updates and may no longer be supported without prior notice. If you have questions about an application provided with the device, contact a Samsung Service Centre. For user-installed applications, contact service providers.
- Modifying the device's operating system or installing softwares from unofficial sources may result in device malfunctions and data corruption or loss. These actions are violations of your Samsung licence agreement and will void your warranty.

Instructional icons



Warning: situations that could cause injury to yourself or others



Caution: situations that could cause damage to your device or other equipment



Note: notes, usage tips, or additional information

Copyright

Copyright © 2013 Samsung Electronics

This guide is protected under international copyright laws.

No part of this guide may be reproduced, distributed, translated, or transmitted in any form or by any means, electronic or mechanical, including photocopying, recording, or storing in any information storage and retrieval system, without the prior written permission of Samsung Electronics.

Trademarks

- SAMSUNG and the SAMSUNG logo are registered trademarks of Samsung Electronics.
- The Android logo, Google™, Google Maps™, Google Mail™, YouTube™, Google Play™ Store, and Google Talk™ are trademarks of Google, Inc.
- Bluetooth® is a registered trademark of Bluetooth SIG, Inc. worldwide.
- Wi-Fi®, Wi-Fi Protected Setup™, Wi-Fi Direct™, Wi-Fi CERTIFIED™, and the Wi-Fi logo are registered trademarks of the Wi-Fi Alliance.
- All other trademarks and copyrights are the property of their respective owners.

DivX®, DivX Certified® and associated logos are trademarks of Rovi Corporation or its subsidiaries and are used under licence.



ABOUT DIVX VIDEO

DivX® is a digital video format created by DivX, LLC, a subsidiary of Rovi Corporation. This is an official DivX Certified® device that has passed rigorous testing to verify that it plays DivX video. Visit www.divx.com for more information and software tools to convert your files into DivX videos.

ABOUT DIVX VIDEO-ON-DEMAND

This DivX Certified® device must be registered in order to play purchased DivX Video-on-Demand (VOD) movies. To obtain your registration code, locate the DivX VOD section in your device setup menu. Go to vod.divx.com for more information on how to complete your registration.

DivX Certified® to play DivX® video up to HD 720p, including premium content.

Manufactured under licence from Dolby Laboratories. Dolby, Dolby Digital Plus, and the double-D symbol are trademarks of Dolby Laboratories.



Table of Contents

Getting started

- 8 Device layout
- 9 Buttons
- 10 Package contents
- 10 Charging the battery
- 13 Inserting a memory card
- 14 Turning the device on and off
- 15 Holding the device
- 15 Locking and unlocking the device
- 15 Adjusting the volume
- 15 Switching to silent mode

Basics

- 16 Indicator icons
- 17 Using the touch screen
- 20 Control motions
- 22 Activating Multi Window
- 23 Notifications
- 23 Quick setting panel
- 24 Home screen
- 27 Locked screen
- 28 Using applications
- 28 Applications screen
- 29 Help
- 30 Entering text

- 32 Connecting to a Wi-Fi network
- 33 Setting up accounts
- 34 Transferring files
- 35 Securing the device
- 37 Upgrading the device

Communication

- 38 Contacts
- 41 Email
- 43 Google Mail
- 44 Talk (Hangouts)
- 44 Google+
- 45 Messenger
- 45 ChatON

Web & network

- 46 Internet
- 47 Chrome
- 48 Bluetooth
- 49 Screen Mirroring
- 50 Samsung Link
- 51 Group Play
- 52 WatchON
- 53 Smart Remote

Media

- 54 Music Player
- 55 Camera
- 61 Gallery
- 64 Story Album
- 66 Paper Artist
- 67 Video Player
- 68 YouTube
- 69 Flipboard

Application & media stores

- 70 Play Store
- 71 Samsung Apps
- 71 Game Hub
- 72 Music Hub
- 73 Play Books
- 73 Play Movies
- 73 Play Music
- 74 Readers Hub
- 74 Learning Hub

Utilities

- 75 Memo
- 76 S Planner
- 78 Dropbox
- 79 Cloud
- 80 Polaris Office
- 82 Alarm
- 83 World Clock

- 84 Calculator
- 84 S Translator
- 85 S Voice
- 86 Google
- 87 Voice Search
- 87 My Files
- 88 Downloads
- 88 TripAdvisor

Travel & local

- 89 Maps
- 90 Local
- 91 Navigation

Settings

- 92 About Settings
- 92 Wi-Fi
- 93 Bluetooth
- 93 Data usage
- 93 More settings
- 94 Blocking mode
- 94 Driving mode
- 95 Sound
- 95 Display
- 96 Storage
- 97 Power saving mode
- 97 Battery
- 97 Application manager
- 97 Location services

Table of Contents

98	Lock screen
99	Security
100	Language and input
103	Cloud
103	Backup and reset
103	Add account
103	Motion
104	Voice control
104	Accessory
104	Date and time
105	Accessibility
106	About device
106	Google Settings

Troubleshooting

Getting started



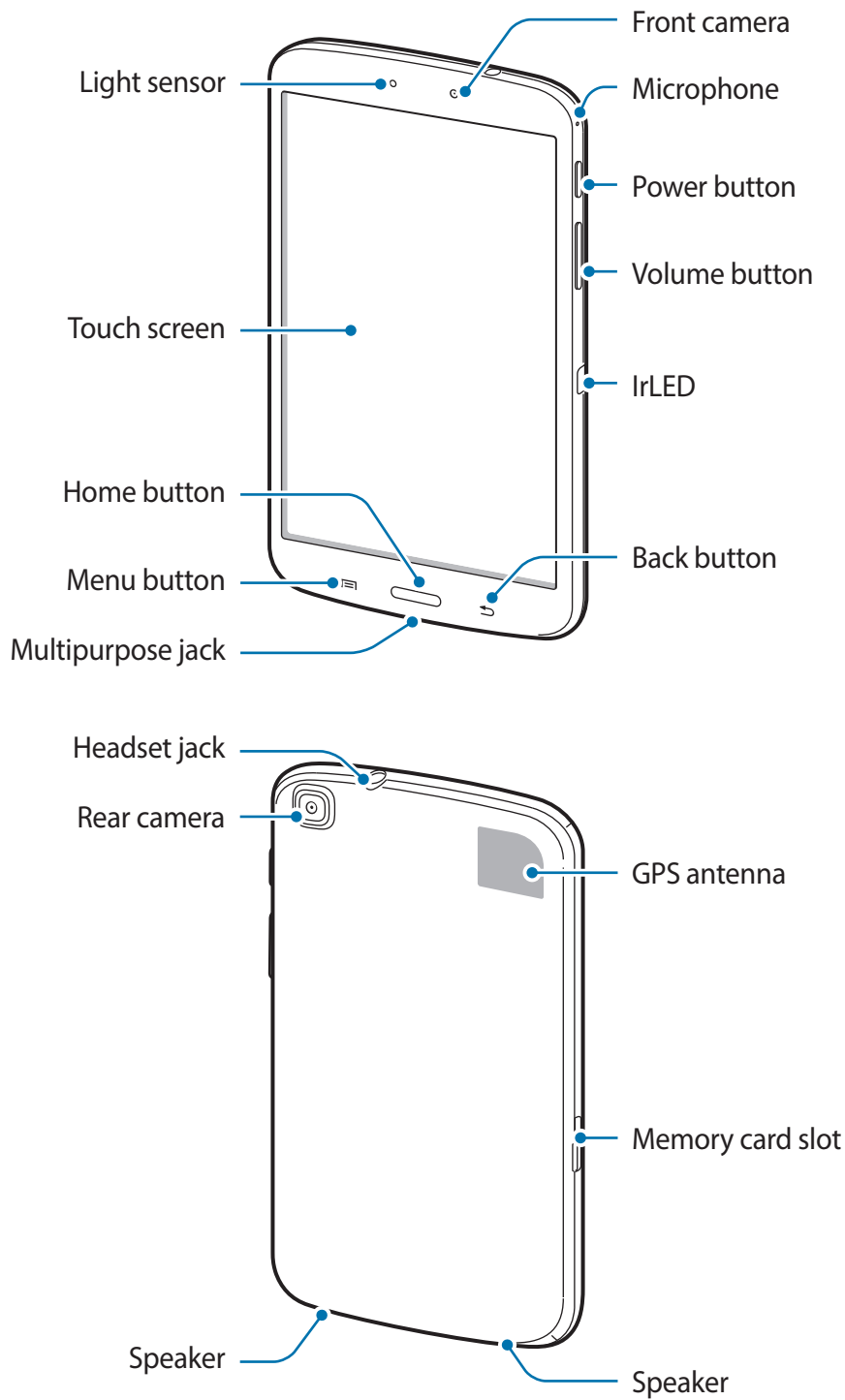

Device layout





- Do not cover the antenna area with your hands or other objects. This may cause connectivity problems or drain the battery.
- Do not use a screen protector. This causes sensor malfunctions.
- Do not allow water to contact the touch screen. The touch screen may malfunction in humid conditions or when exposed to water.

Buttons

Button	Function
 Power	<ul style="list-style-type: none"> • Press and hold to turn the device on or off. • Press and hold for 8-10 seconds to reset the device if it has fatal errors or hang-ups, or freezes. • Press to lock or unlock the device. The device goes into lock mode when the touch screen turns off.
 Menu	<ul style="list-style-type: none"> • Tap to open a list of options available for the current screen. • Tap and hold on the Home screen to launch Google search.
 Home	<ul style="list-style-type: none"> • Press to return to the Home screen. • Press and hold to open the list of recent applications.
 Back	<ul style="list-style-type: none"> • Tap to return to the previous screen.
 Volume	<ul style="list-style-type: none"> • Press to adjust the device volume.

Package contents

Check the product box for the following items:

- Device
- Quick start guide



- The items supplied with the device and any available accessories may vary depending on the region or service provider.
- The supplied items are designed only for this device and may not be compatible with other devices.
- Appearances and specifications are subject to change without prior notice.
- You can purchase additional accessories from your local Samsung retailer. Make sure they are compatible with the device before purchase.
- Other accessories may not be compatible with your device.
- Use only Samsung-approved accessories. Malfunctions caused by using unapproved accessories are not covered by the warranty service.
- Availability of all accessories is subject to change depending entirely on manufacturing companies. For more information about available accessories, refer to the Samsung website.

Charging the battery

Use the charger to charge the battery before using it for the first time.



Use only Samsung-approved chargers, batteries, and cables. Unapproved chargers or cables can cause the battery to explode or damage the device.



- When the battery power is low, the device emits a warning tone and displays a low battery power message.
- If the battery is completely discharged, the device cannot be turned on immediately when the charger is connected. Allow a depleted battery to charge for a few minutes before turning on the device.

Charging with the charger

Connect the USB cable to the USB power adaptor and then plug the end of the USB cable into the multipurpose jack.

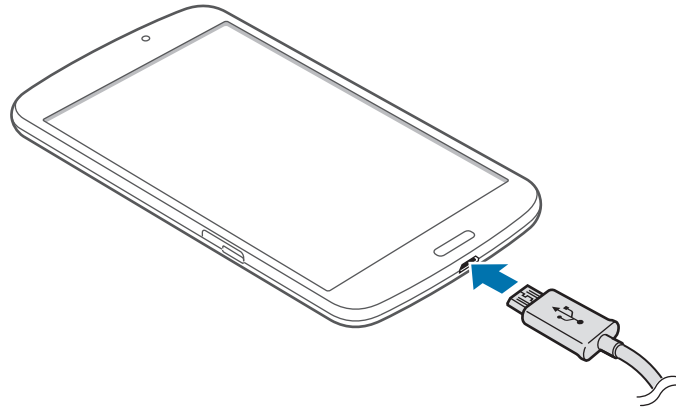

Connecting the charger improperly may cause serious damage to the device. Any damage caused by misuse is not covered by the warranty.



- The device can be used while it is charging, but it may take longer to fully charge the battery.
- If the device receives an unstable power supply while charging, the touch screen may not function. If this happens, unplug the charger from the device.
- While charging, the device may heat up. This is normal and should not affect the device's lifespan or performance. If the battery gets hotter than usual, the charger may stop charging.
- If the device is not charging properly, take the device and the charger to a Samsung Service Centre.

After fully charging, disconnect the device from the charger. First unplug the charger from the device, and then unplug it from the electric socket.



To save energy, unplug the charger when not in use. The charger does not have a power switch, so you must unplug the charger from the electric socket when not in use to avoid wasting power. The device should remain close to the electric socket while charging.

Checking the battery charge status

When you charge the battery while the device is off, the following icons will show the current battery charge status:



Charging



Fully charged

Reducing the battery consumption

Your device provides options that help you save battery power. By customising these options and deactivating features in the background, you can use the device longer between charges:

- When you are not using the device, switch to sleep mode by pressing the Power button.
- Close unnecessary applications with the task manager.
- Deactivate the Bluetooth feature.
- Deactivate the Wi-Fi feature.
- Deactivate auto-syncing of applications.
- Decrease the backlight time.
- Decrease the brightness of the display.

Inserting a memory card

Your device accepts memory cards with maximum capacities of 64 GB. Depending on the memory card manufacturer and type, some memory cards may not be compatible with your device.



- Some memory cards may not be fully compatible with the device. Using an incompatible card may damage the device or the memory card, or corrupt the data stored in it.
- Use caution to insert the memory card right-side up.



- The device supports only the FAT file system for memory cards. When inserting a card formatted in a different file system, the device asks to reformat the memory card.
- Frequent writing and erasing of data shortens the lifespan of memory cards.
- When inserting a memory card into the device, the memory card's file directory appears in the **SD memory card** folder under the internal memory.

- 1 Insert a memory card with the gold-coloured contacts facing downwards.
- 2 Push the memory card into the slot until it locks in place.

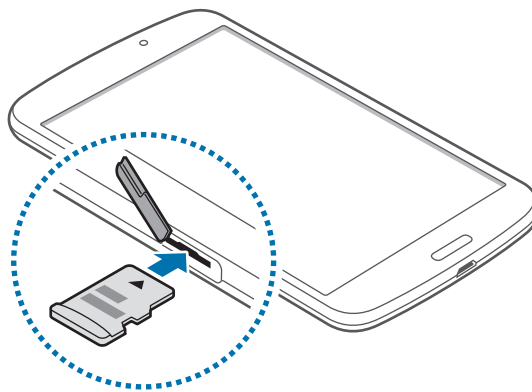

Removing the memory card

Before removing the memory card, first unmount it for safe removal. On the Home screen, tap **Apps** → **Settings** → **Storage** → **Unmount SD card**.

Push the memory card until it disengages from the device, and then pull it out.



Do not remove the memory card while the device is transferring or accessing information. Doing so can cause data to be lost or corrupted or damage to the memory card or device. Samsung is not responsible for losses that result from the misuse of damaged memory cards, including the loss of data.

Formatting the memory card

A memory card formatted on a computer may not be compatible with the device. Format the memory card on the device.

On the Home screen, tap **Apps** → **Settings** → **Storage** → **Format SD card** → **Format SD card** → **Erase everything**.



Before formatting the memory card, remember to make backup copies of all important data stored on the device. The manufacturer's warranty does not cover loss of data resulting from user actions.

Turning the device on and off

When turning on the device for the first time, follow the on-screen instructions to set up your device.

Press and hold the Power button for a few seconds to turn on the device.

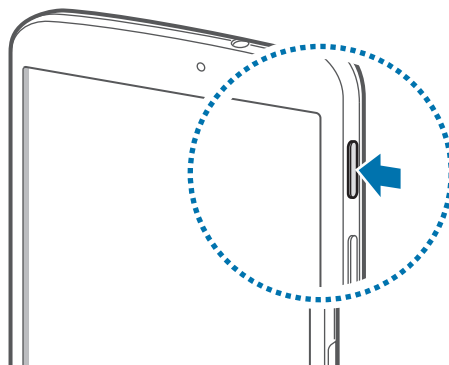



- Follow all posted warnings and directions from authorised personnel in areas where the use of wireless devices is restricted, such as aeroplanes and hospitals.
- Press and hold the Power button and tap **Flight mode** to disable the wireless features.

To turn off the device, press and hold the Power button, and then tap **Power off**.

Holding the device

Do not cover the antenna area with your hands or other objects. This may cause connectivity problems or drain the battery.

Locking and unlocking the device

When not in use, lock the device to prevent unwanted operation. Pressing the Power button turns off the screen and puts the device into lock mode. The device automatically gets locked if it is not used for a specified period.

To unlock the device, press the Power button or the Home button and flick your finger in any direction within the unlock screen area at the lower part of the screen.

Adjusting the volume

Press the Volume button up or down to adjust the ringtone volume, or to adjust the sound volume when playing music or video.

Switching to silent mode











Use one of the following methods:

- Press and hold the Volume button down until it switches to silent mode.
- Press and hold the Power button, and then tap **Mute**.
- Open the notifications panel at the top of the screen, and then tap **Sound**.

Basics

Indicator icons

The icons displayed at the top of the screen provide information about the status of the device. The icons listed in the table below are most common.

Icon	Meaning
	Wi-Fi connected
	Bluetooth feature activated
	GPS activated
	Synced with the web
	Connected to computer
	Alarm activated
	Silent mode activated
	Flight mode activated
	Error occurred or caution required
	Battery power level

Using the touch screen

Use only fingers to use the touch screen.



- Do not allow the touch screen to come into contact with other electrical devices. Electrostatic discharges can cause the touch screen to malfunction.
- Do not allow the touch screen to contact water. The touch screen may malfunction in humid conditions or when exposed to water.
- To avoid damaging the touch screen, do not tap it with anything sharp or apply excessive pressure to it with your fingertips.
- Leaving the touch screen idle for extended periods may result in afterimages (screen burn-in) or ghosting. Turn off the touch screen when you do not use the device.

Finger gestures

Tapping

To open an application, to select a menu item, to press an on-screen button, or to enter a character using the on-screen keyboard, tap it with a finger.

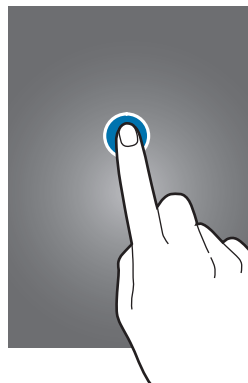

Dragging

To move an icon, thumbnail, or preview to a new location, tap and hold it and drag it to the target position.

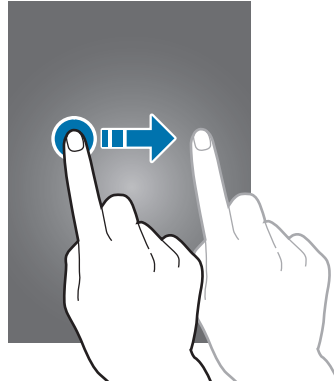

Double-tapping

Double-tap on a webpage, map, or image to zoom in a part. Double-tap again to return.

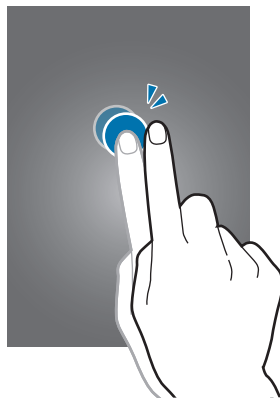

Flicking

Flick left or right on the Home screen or the Applications screen to see another panel. Flick up or down to scroll through a webpage or a list, such as contacts.

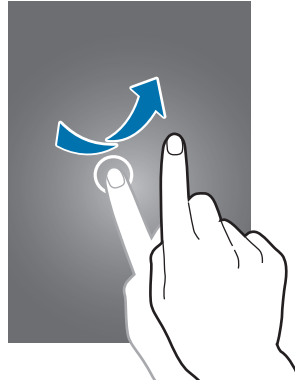

Pinching

Spread two fingers apart on a webpage, map, or image to zoom in a part. Pinch to zoom out.

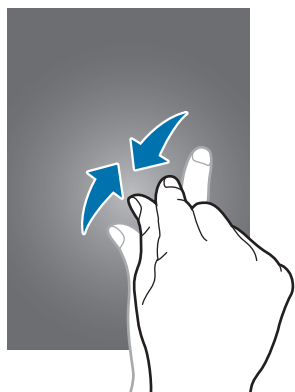

Control motions

Simple motions allow easy control of the device.

Before using motions, make sure the motion feature is activated. On the Home screen, tap **Apps** → **Settings** → **Motion**, and then drag the switch at the top right of the screen to the right.

Rotating the screen

Many applications allow display in either portrait or landscape orientation. Rotating the device causes the display to automatically adjust to fit the new screen orientation.

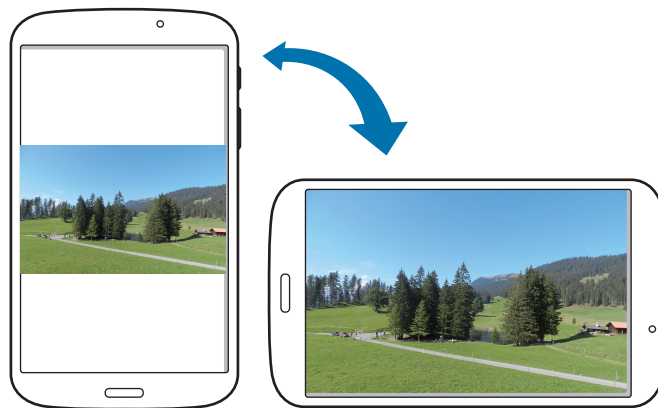

To prevent the display from rotating automatically, open the notifications panel and deselect **Screen rotation**.



- Some applications do not allow screen rotation.
- Some applications display a different screen depending on the orientation. The calculator turns into a scientific calculator when rotated to landscape.

Sweeping

Sweep your hand across the screen to capture a screenshot. The image is saved in **Gallery** → **Screenshots**. It is not possible to capture a screenshot while using some applications.

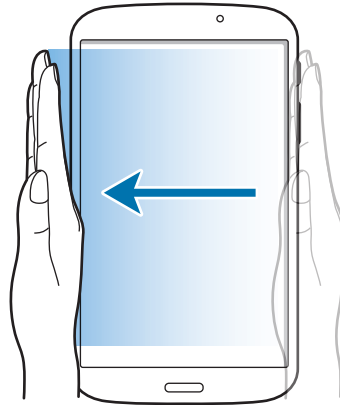

Covering

Cover the screen with a palm to pause media playback.

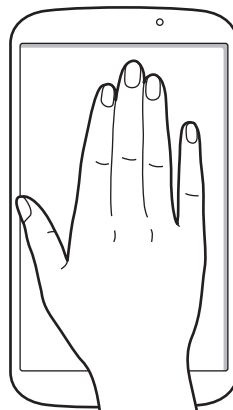

Activating Multi Window



Use this feature to run two applications on the screen at the same time.



- Only applications on the Multi Window panel can run.
- When launching applications that contain multimedia files, such as music or videos, sound from both files will be played.
- This feature may not be available depending on the region or service provider.

To use Multi Window, on the Applications screen, tap **Settings** → **Display**, and then tick **Multi window**.

Using the Multi Window panel

To activate the Multi Window panel, tap and hold . The Multi Window panel appears at the left side of the screen. Select one application, and then drag another application to a new location. To deactivate the Multi Window panel, tap and hold  again.

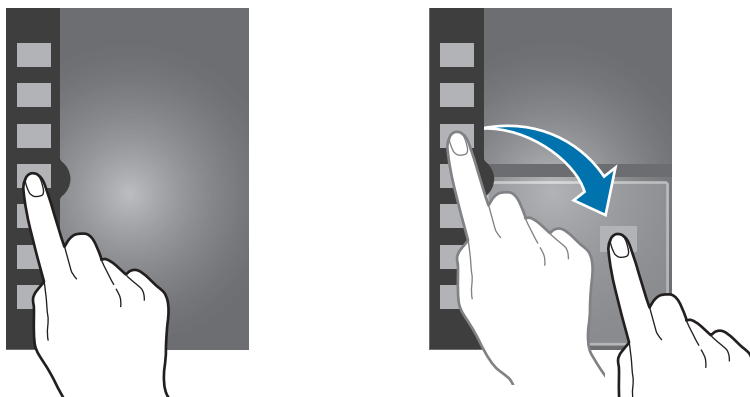



Drag the bar between the application panels up or down to adjust the size of the panels.

Tap the panel handle to hide or show the panel. Tap and hold the handle and drag it to the left or right edge of the screen to move the panel. When a panel is hidden, tap and hold the handle and drag it up or down to move the handle.

Using Multi Window applications

While using Multi Window applications, tap  or  and use one of the following:

-  : Switch locations between Multi Window applications.
-  : Maximise the window to fit the screen.
-  : Close the application.

Notifications

Notification icons appear on the status bar at the top of the screen to report new messages, calendar events, device status, and more. Drag down from the status bar to open the notifications panel. Scroll the list to see additional alerts. To close the notifications panel, drag up the bar that is at the bottom of the screen.

Quick setting panel

From the quick setting panel, you can view your device's current settings. Drag down from the status bar, tap  to open the quick setting panel, and then use the following options:

- **Wi-Fi:** Activate or deactivate the Wi-Fi feature.
- **GPS:** Activate or deactivate the GPS feature.
- **Reading mode:** Activate or deactivate reading mode. In reading mode, the device helps protect your eyes when reading at night. To select which applications will be used for, tap **Settings** → **Display** → **Reading mode**.
- **Sound:** Activate or deactivate silent mode.
- **Screen rotation:** Allow or prevent the interface from rotating when you rotate the device.
- **Bluetooth:** Activate or deactivate the Bluetooth feature.

- **Blocking mode:** Activate or deactivate blocking mode. In blocking mode, the device will block notifications. To select which notifications will be blocked, tap **Settings** → **Blocking mode**.
- **Power saving:** Activate or deactivate power-saving mode.
- **Screen Mirroring:** Activate or deactivate the screen mirroring feature.
- **Multi window:** Set to use Multi Window.
- **Driving mode:** Activate or deactivate driving mode.
- **Smart stay:** Activate or deactivate the smart stay feature.
- **Sync:** Activate or deactivate auto-syncing of applications.
- **Flight mode:** Activate or deactivate flight mode.



The available options may vary depending on the region or service provider.

To rearrange the options on the quick setting panel, open the quick setting panel, tap , and then tap and drag an item to another location.

Home screen

The Home screen is the starting point to access all of the device's features. It displays indicator icons, widgets, shortcuts to applications, and others.

The Home screen can have multiple panels. To view other panels, scroll left or right.

Rearranging items

Adding an application icon

On the Home screen, tap **Apps**, tap and hold an application icon, and then drag it into a panel preview.

Adding an item

Customise the Home screen by adding widgets, folders, or panels.

Tap and hold the empty area on the Home screen, and then select one of the following categories:

- **Apps and widgets:** Add widgets or applications to the Home screen.
- **Folder:** Create a new folder.
- **Page:** Add a new panel to the Home screen.

Moving an item

Tap and hold an item and drag it to a new location. To move it to another panel, drag it to the side of the screen.

Removing an item

Tap and hold an item, and drag it to the rubbish bin that appears at the top of the Home screen. When the rubbish bin turns red, release the item.

Rearranging panels

Adding a new panel

Tap  → **Edit page** → .

Moving a panel

Tap  → **Edit page**, tap and hold a panel preview, and then drag it to a new location.

Removing a panel

Tap  → **Edit page**, tap and hold a panel preview, and then drag it to the rubbish bin at the top of the screen.

Setting wallpaper

Set an image or photo stored in the device as wallpaper for the Home screen.

On the Home screen, tap  → **Set wallpaper** → **Home screen**, and then select one of the following:

- **Gallery:** See photos taken by the device's camera or images downloaded from the Internet.
- **Live wallpapers:** See animated images.
- **Wallpapers:** See wallpaper images.

Then, select an image and tap **Set wallpaper**. Or, select an image, resize it by dragging the frame, and then tap **Done**.

Using widgets

Widgets are small applications that provide convenient functions and information on your Home screen. To use them, add widgets from the widgets panel to the Home screen.



- Some widgets connect to web services. Using a web-based widget may result in additional charges.
- The widgets available may vary depending on the region or service provider.

Adding widgets to the Home screen

On the Home screen, tap **Apps** → **Widgets**. Scroll left or right on the widgets panel, and then tap and hold a widget to add it to the Home screen.

Using the setting shortcut widget

On the Home screen, tap **Apps** → **Widgets**, and then tap and hold **Settings Shortcut** to open a list of setting options. Select a setting option to add it to the Home screen as a shortcut.

Locked screen

The locked screen prevents the device from unwanted operation when not in use and also allows you to add convenient widgets.

Adding widgets

To use widgets when the screen is locked, on the Applications screen, tap **Settings** → **Lock screen**, and then tick **Multiple widgets**.



You cannot use widgets on the locked screen when the security features are activated.

Tap the widgets panel area at the upper part of the screen. Scroll right to the last page, tap , and then select a widget to add to the locked screen.



Rearranging panels

Moving a panel

Scroll left or right on the widgets panel area, tap and hold a panel preview, and then drag it to a new location.

Removing a panel

Scroll left or right on the widgets panel area, tap and hold a panel preview, and then drag it to the rubbish bin at the top of the screen.

Using applications

This device can run many different types of applications, ranging from media to Internet applications.

Opening an application

On the Home screen or the Applications screen, select an application icon to open it.



Opening from recently-used applications

Press and hold the Home button to open the list of recently-used applications.

Select an application icon to open.

Closing an application

Close applications not in use to save battery power and maintain device performance.

Press and hold the Home button, tap , and then tap **End** next to an application to close it. To close all running applications, tap **End all**. Alternatively, press and hold the Home button, and then tap .

Applications screen

The Applications screen displays icons for all applications, including any new applications installed.

On the Home screen, tap **Apps** to open the Applications screen.

To view other panels, scroll left or right.

Rearranging applications

Tap  → **Edit**, tap and hold an application, and then drag it to a new location. To move it to another panel, drag it to the side of the screen.

Organising with folders

Put related applications together in a folder for convenience.

Tap  → **Edit**, tap and hold an application, and then drag it to **Create folder**. Enter a folder name and then tap **OK**. Put applications into the new folder by dragging, and then tap **Save** to save the arrangement.

Rearranging panels

Pinch on the screen, tap and hold a panel preview, and then drag it to a new location.

Installing applications

Use application stores, such as **Samsung Apps**, to download and install applications.

Uninstalling applications

Tap  → **Uninstall**, and then select an application to uninstall it.



Default applications that come with the device cannot be uninstalled.

Sharing applications

Share downloaded applications with other users via email, Bluetooth, or other methods.

Tap  → **Share app**, select applications, tap **Done**, and then select a sharing method. The next steps vary depending on the method selected.

Help

Access help information to learn how to use the device and applications or configure important settings.

Tap **Help** on the Applications screen. Select an item to view tips.

Entering text

Use the Samsung keyboard or the voice input feature to enter text.



Text entry is not supported in some languages. To enter text, you must change the input language to one of the supported languages.

Changing the keyboard type

Tap any text field, open the notifications panel, tap **Choose input method**, and then select the type of keyboard to use.

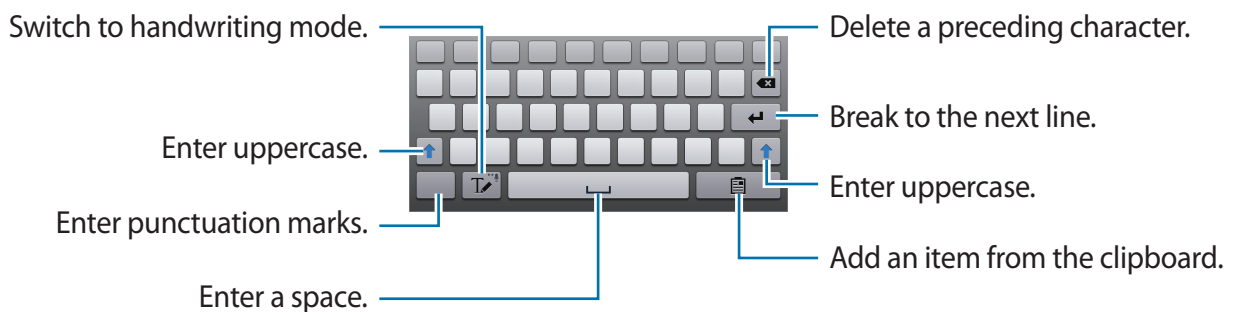

Using the Samsung keyboard



Entering uppercase

Tap  before entering a character. For all caps, tap it twice.

Changing the keyboard type

Tap and hold , and then tap  to change the keyboard type. Tap and hold  and move the floating keyboard to another location.

To switch to the fixed keyboard, tap .

Changing language keyboards

Add languages on the keyboard, and then slide the space key left or right to change language keyboards.

Handwriting

Tap , and then write a word with a finger. Suggested words appear as characters are entered. Select a suggested word.





Entering text by voice

Activate the voice input feature and then speak into the microphone. The device displays what you speak.

If the device does not recognise your words correctly, tap the underlined text and select an alternative word or phrase from the dropdown list.

To change the language or add languages for the voice recognition, tap the current language.

Copying and pasting

Tap and hold over text, drag  or  to select more or less text, and then tap **Copy** to copy or **Cut** to cut. The selected text is copied to the clipboard.

To paste it into a text entry field, tap and hold at the point where it should be inserted, and then tap **Paste**.

Connecting to a Wi-Fi network

Connect the device to a Wi-Fi network to use the Internet or share media files with other devices. (p. 92)



Ensure that the Wi-Fi connection is active before using Internet applications.

Turning Wi-Fi on and off

Open the notifications panel, and then tap **Wi-Fi** to turn it on or off.



- Your device uses a non-harmonised frequency and is intended for use in all European countries. The WLAN can be operated in the EU without restriction indoors, but cannot be operated outdoors.
- Turn off Wi-Fi to save the battery when not in use.

Joining Wi-Fi networks

On the Applications screen, tap **Settings** → **Wi-Fi**, and then drag the **Wi-Fi** switch to the right. Select a network from the list of detected Wi-Fi networks, enter a password if necessary, and then tap **Connect**. Networks that require a password appear with a lock icon. After the device connects to a Wi-Fi network, the device will automatically connect to it any time it is available.

Adding Wi-Fi networks

If the desired network does not appear in the networks list, tap **Add Wi-Fi network** at the bottom of the networks list. Enter the network name in **Network SSID**, select the security type and enter the password if it is not an open network, and then tap **Connect**.

Forgetting Wi-Fi networks

Any network that has ever been used, including the current network, can be forgotten so the device will not automatically connect to it. Select the network in the networks list, and then tap **Forget**.

Setting up accounts

Google applications, such as **Play Store**, require a Google account, and **Samsung Apps** requires a Samsung account. Create Google and Samsung accounts to have the best experience with the device.

Adding accounts

Follow the instructions that appear when opening a Google application without signing in to set up a Google account.

To sign in with or sign up for a Google account, on the Applications screen, tap **Settings** → **Add account** → **Google**. After that, tap **New** to sign up, or tap **Existing**, and then follow on-screen instructions to complete the account setup. More than one Google account can be used on the device.

Set up a Samsung account as well.

Removing accounts

On the Applications screen, tap **Settings**, select an account name under **Accounts**, select the account to remove, and then tap **Remove account**.

Transferring files

Move audio, video, image, or other types of files from the device to the computer, or vice versa.



The following file formats are supported by some applications. Some file formats are not supported depending on the version of the device's software or the computer operating system.

- Music: mp3, m4a, mp4, 3gp, 3ga, wma, ogg, oga, aac, and flac
- Image: bmp, gif, jpg, and png
- Video: 3gp, mp4, avi, wmv, flv, asf, and mkv
- Document: doc, docx, dot, dotx, xls,xlsx, xlt, xlsx, csv, ppt, pptx, pps, ppsx, pot, potx, pdf, hwp, txt, asc, rtf, and zip

Connecting with Samsung Kies

Samsung Kies is a computer application that manages media libraries, contacts, and calendars, and syncs them with Samsung devices. Download the latest Samsung Kies from the Samsung website.

- 1 Connect the device to the computer using the USB cable.
Samsung Kies launches on the computer automatically. If Samsung Kies does not launch, double-click the Samsung Kies icon on the computer.
- 2 Transfer files between your device and the computer.
Refer to the Samsung Kies help for more information.

Connecting with Windows Media Player

Ensure that Windows Media Player is installed on the computer.

- 1 Connect the device to the computer using the USB cable.
- 2 Open Windows Media Player and sync music files.

Connecting as a media device

- 1 Connect the device to the computer using the USB cable.
- 2 Open the notifications panel, and then tap **Connected as a media device** → **Media device (MTP)**.

Tap **Camera (PTP)** if your computer does not support Media Transfer Protocol (MTP) or not have any appropriate driver installed.

- 3 Transfer files between your device and the computer.

Securing the device

Prevent others from using or accessing personal data and information stored in the device by using the security features. The device requires an unlock code whenever unlocking it.

Setting a face unlock

On the Applications screen, tap **Settings** → **Lock screen** → **Screen lock** → **Face unlock**.

Fit your face in the frame to be captured. Then, set a backup unlock PIN or pattern to unlock the screen in case the face unlock fails.

Setting a face and voice unlock

On the Applications screen, tap **Settings** → **Lock screen** → **Screen lock** → **Face and voice**. Fit your face in the frame to be captured and then set a voice command. Then, set a backup unlock PIN or pattern to unlock the screen in case the face and voice unlock fails.

Setting a pattern

On the Applications screen, tap **Settings** → **Lock screen** → **Screen lock** → **Pattern**. Draw a pattern by connecting four dots or more, and then draw the pattern again to verify it. Set a backup unlock PIN to unlock the screen when you forget the pattern.

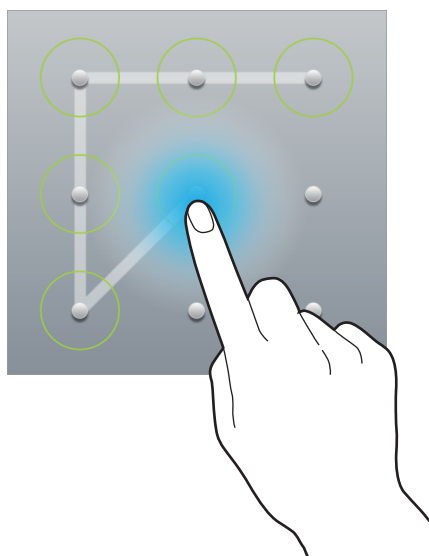

Setting a PIN

On the Applications screen, tap **Settings** → **Lock screen** → **Screen lock** → **PIN**. Enter at least four numbers, and then enter the password again to verify it.

Setting a password

On the Applications screen, tap **Settings** → **Lock screen** → **Screen lock** → **Password**. Enter at least four characters including numbers and symbols, and then enter the password again to verify it.

Unlocking the device

Turn on the screen by pressing the Power button or the Home button, and enter the unlock code.



If the unlock code is forgotten, take the device to a Samsung Service Centre to reset it.

Upgrading the device

The device can be upgraded to the latest software.



This feature may not be available depending on the region or service provider.

Upgrading with Samsung Kies

Launch Samsung Kies and connect the device to the computer. Samsung Kies automatically recognises the device and shows available updates in a dialogue box, if any. Click the Update button in the dialogue box to start upgrading. Refer to the Samsung Kies help for details on how to upgrade.



- Do not turn off the computer or disconnect the USB cable while the device is upgrading.
- While upgrading the device, do not connect other media devices to the computer. Doing so may interfere with the update process.

Upgrading over the air

The device can be directly upgraded to the latest software by the firmware over-the-air (FOTA) service.

On the Applications screen, tap **Settings** → **About device** → **Software update** → **Update**.

Communication

Contacts



Use this application to manage contacts, including phone numbers, email addresses, and others.

Tap **Contacts** on the Applications screen.

Managing contacts

Creating a contact

Tap  and enter contact information.

-  : Add an image.
-  /  : Add or delete a contact field.

Editing a contact

Select a contact to edit, and then tap .

Deleting a contact



Tap .

Searching for contacts

Use one of the following search methods:

- Scroll up or down the contacts list.
- Use the index at the left side of the contacts list for quick scrolling, by dragging a finger along it.
- Tap the search field at the top of the contacts list and enter search criteria.

Once a contact is selected, take one of the following actions:

-  : Add to favourite contacts.
-  : Compose an email.

Displaying contacts

By default, the device shows all saved contacts on the device or another account.

Tap  → **Contacts to display**, and then select a location where contacts are saved.

Moving contacts

Moving contacts to Google

Tap  → **Merge accounts** → **Merge with Google**.

Contacts moved to Google Contacts appear with  in the contacts list.

Moving contacts to Samsung

Tap  → **Merge accounts** → **Merge with Samsung**.

Contacts moved to Samsung Contacts appear with  in the contacts list.

Importing and exporting contacts

Importing contacts

Tap  → **Import/Export** → **Import from SD card** or **Import from USB storage**.

Exporting contacts

Tap  → **Import/Export** → **Export to SD card** or **Export to USB storage**.

Sharing contacts

Tap  → **Import/Export** → **Share namecard via**, select contacts, tap **Done**, and then select a sharing method.

Favourite contacts

Tap **Contacts** → **Favourites**.

Tap , and then take one of the following actions:

- **Search:** Search for contacts.
- **Add to favourites:** Add contacts to favourites.
- **Remove from favourites:** Remove contacts from favourites.
- **Grid view / List view:** View contacts in grid or list form.
- **Help:** Access help information about using contacts.

Contact groups

Tap **Contacts** → **Groups**.

Adding contacts to a group

Select a group, and then tap  → **Add member**. Select contacts to add, and then tap **Done**.

Managing groups

Tap , and then take one of the following actions:

- **Search:** Search for contacts.
- **Edit:** Change the group settings.
- **Add member:** Add members to the group.
- **Remove member:** Remove members from the group.
- **Send email:** Send an email to a group's members.
- **Change order:** Tap and hold  next to the group name, drag it up or down to another position, and then tap **Done**.
- **Help:** Access help information about using contacts.

Deleting groups

Tap , select user-added groups, and then tap **Delete**. Default groups cannot be deleted.

Sending an email to a group's members

Select a group, tap  → **Send email**, select members, and then tap **Done**.

Business card

Create a business card and send it to others.

Tap **Set up my profile**, enter details, such as phone number, email address, and postal address, and then tap **Save**. If user information has been saved when you set up the device, select the business card in **ME**, and then tap  to edit.

Tap  → **Share namecard via**, and then select a sharing method.

Email

Use this application to send or view email messages.

Tap **Email** on the Applications screen.

Setting up email accounts

Set up an email account when opening **Email** for the first time.

Enter the email address and password. Tap **Next** for a private email account, such as Google Mail, or tap **Manual setup** for a company email account. After that, follow on-screen instructions to complete the setup.

To set up another email account, tap  → **Settings** → **Add account**.

Sending messages

Tap the email account to use, and then tap  at the top of the screen. Enter recipients, subject, and message, and then tap **Send**.

Tap  to add a recipient from the contacts list.

Tap **+Cc/Bcc** to add more recipients.

Tap  to attach images, videos, contacts, memos, events, and others.

Tap  to insert images, events, contacts, location information, and others into the message.

Sending scheduled messages

While composing a message, tap . Tick **Schedule sending**, set a time and date, and then tap **Done**. The device will send the message at the specified time and date.



- If the device is turned off at the scheduled time, is not connected to the network, or the network is unstable, the message will not be sent.
- This feature is based on the time and date set on the device. The time and date may be incorrect if you move across time zones and the network does not update the information.

Reading messages

Select an email account to use, and new messages are retrieved. To manually retrieve new messages, tap .

Tap a message to read.

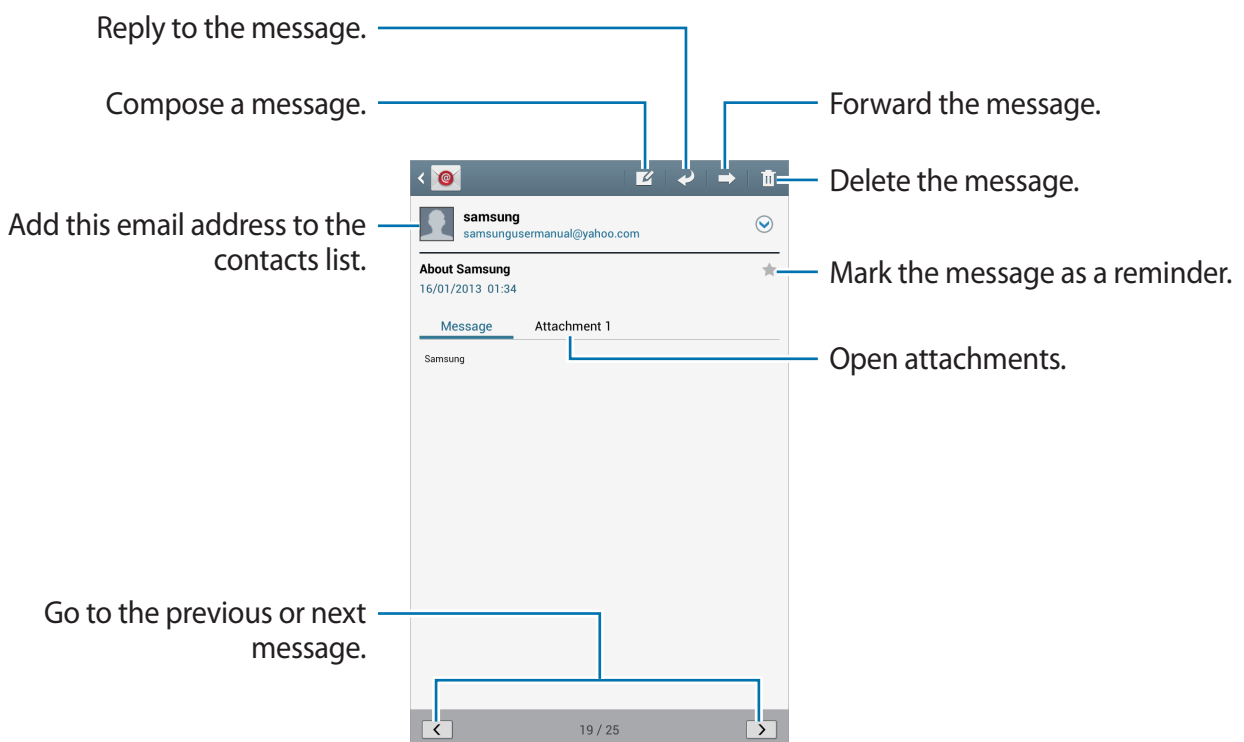

Tap the attachment tab to open attachments, and then tap **Save** to save it.

Google Mail

Use this application to quickly and directly access the Google Mail service.

Tap **Google Mail** on the Applications screen.



- This application may not be available depending on the region or service provider.
- This application may be labelled differently depending on the region or service provider.

Sending messages

In any mailbox, tap , enter recipients, a subject, and a message, and then tap **SEND**.

Tap **+CC/BCC** to add more recipients.

Tap  to attach images.

Tap  → **Save draft** to save the message for later delivery.

Tap  → **Attach video** to attach videos.

Tap  → **Discard** to start over.

Reading messages

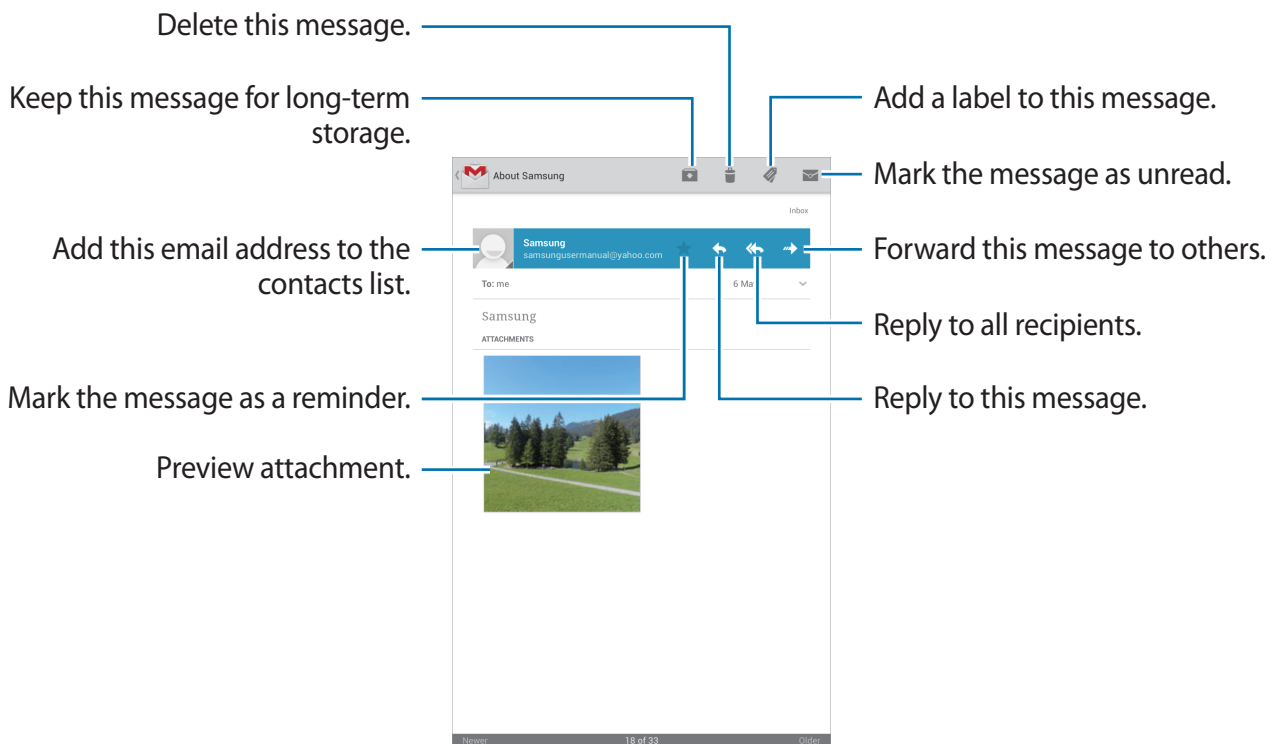

Labels

Google Mail does not use actual folders, but uses labels instead. When Google Mail is launched, it displays messages labelled Inbox.

To add a label to a message, select the message, tap , and then select the label to assign.

Talk (Hangouts)

Use this application to chat with others.

Tap **Talk (Hangouts)** on the Applications screen.



This application may not be available depending on the region or service provider.

Select a friend from the friends list or enter data to search and select a friend from the results to start chatting.

Google+

Use this application to stay connected with people via Google's social network service.

Tap **Google+** on the Applications screen.



This application may not be available depending on the region or service provider.

Tap **All Circles** to change the category, and then scroll up or down to view posts from your circles.

Tap  to use other social network features.

Messenger

Use this application to chat with others via Google+ instant messaging service.

Tap **Messenger** on the Applications screen.



This application may not be available depending on the region or service provider.

Select a friend from the friends list, enter a message in the field at the bottom of the screen, and then tap ►.

ChatON

Use this application to chat with any device. To use this application, you must sign in to your Samsung account.

Tap **ChatON** on the Applications screen.



This application may not be available depending on the region or service provider.

Create the buddies list by entering phone numbers or email addresses of Samsung accounts, or selecting buddies from the list of suggestions.

Select a buddy to start chatting.

To sync contacts on the device with ChatON, tap **More** → **Settings** → **Contact sync**.

Web & network

Internet

Use this application to browse the Internet.

Tap **Internet** on the Applications screen.

Viewing webpages

Tap the address field, enter the web address, and then tap **Go**.

Tap  to share, save, or print the current webpage while viewing a webpage.

Opening a new page

Tap .

To go to another webpage, scroll left or right on the title field, and tap the page to select it.

Searching the web by voice

Tap the address field, tap , speak a keyword, and then select one of the suggested keywords that appear.





This feature may not be available depending on the region or service provider.

Bookmarks

To bookmark the current webpage, tap .

To open a bookmarked webpage, tap , and then select one.

History

Tap  → **History** to open a webpage from the list of recently-visited webpages. To clear the history, tap  → **Clear history**.

Tap  → **History** → **Most visited** to open a webpage from the list of most visited webpages.

Saved pages

To view saved webpages, tap  → **Saved pages**.

Links

Tap and hold a link on the webpage to open it in a new page, save, or copy.

To view saved webpages, tap  → **Downloads**.

Sharing webpages

To share a webpage address with others, tap  → **Share page**.

To share a part of a webpage, tap and hold the desired text, and then tap **Share**.

Chrome

Use this application to search for information and browse webpages.

Tap **Chrome** on the Applications screen.



This application may not be available depending on the region or service provider.

Viewing webpages

Tap the address field, and then enter a web address or search criteria.

Opening a new page

Tap  → **New tab**.

To go to another webpage, scroll left or right on the title field, and tap the page to select it.

Searching the web by voice

Tap the address field, tap , speak a keyword, and then select one of the suggested keywords that appear.

Syncing with other devices

Sync open tabs and bookmarks to use with Chrome on another device, when you are logged in with the same Google account.

To view open tabs on other devices, tap  → **Other devices**. Select a webpage to open.

To view bookmarks, tap  → **Bookmarks**.

Bluetooth

Bluetooth creates a direct wireless connection between two devices over short distances. Use Bluetooth to exchange data or media files with other devices.



- Samsung is not responsible for the loss, interception, or misuse of data sent or received via the Bluetooth feature.
- Always ensure that you share and receive data with devices that are trusted and properly secured. If there are obstacles between the devices, the operating distance may be reduced.
- Some devices, especially those that are not tested or approved by the Bluetooth SIG, may be incompatible with your device.
- Do not use the Bluetooth feature for illegal purposes (for example, pirating copies of files or illegally tapping communications for commercial purposes).

Samsung is not responsible for the repercussion of illegal use of the Bluetooth feature.

To activate Bluetooth, on the Applications screen, tap **Settings** → **Bluetooth**, and then drag the **Bluetooth** switch to the right.

Pairing with other Bluetooth devices

On the Applications screen, tap **Settings** → **Bluetooth** → **Scan**, and detected devices are listed. Select the device you want to pair with, and then accept the auto-generated passkey on both devices to confirm.

Sending and receiving data

Many applications support data transfer via Bluetooth. An example is **Gallery**. Open **Gallery**, select an image, tap  → **Bluetooth**, and then select one of the Bluetooth devices. After that, accept the Bluetooth authorisation request on the other device to receive the image. The transferred file is saved in the **Bluetooth** folder. If a contact is received, it is added to the contacts list automatically.

Screen Mirroring

Use this feature to connect your device to a large screen with an AllShare Cast dongle or HomeSync and then share your contents. You can also use this feature with other devices that support the Wi-Fi Miracast feature.



- This feature may not be available depending on the region or service provider.
- Miracast-enabled devices that do not support High-bandwidth Digital Content Protection (HDCP) may not be compatible with this feature.
- Some files may be buffered during playback, depending on the network connection.
- To save energy, deactivate this feature when not in use.
- If you specify a Wi-Fi frequency, AllShare Cast dongles or HomeSync may not be discovered or connected.
- If you play videos or games on a TV, select an appropriate TV mode to get the best experience.

On the Applications screen, tap **Settings** → **More settings** → **Screen Mirroring**, and then drag the **Screen Mirroring** switch to the right. Select a device, open or play a file, and then control the display with the keys on your device. To connect to a device using a PIN, tap and hold the device name to enter the PIN.

Samsung Link

Use this application to play contents saved on various devices over the Internet. You can play and send multimedia files on your device to another device or web storage service.

To use this application, you must sign in to your Samsung account and register two or more devices. The registration methods may vary depending on the device type. To get more details, tap  → **Help**.

Tap **Samsung Link** on the Applications screen.



This application may not be available depending on the region or service provider.

When opening this application, recent contents from all your registered devices will appear. You can browse and play them. To start sharing files, scroll to **DEVICES & STORAGE** and select an option.

Sending files

Send files to other devices or upload them to web storage services.

Select your device, tap , select files, tap **Done**, and then select a device or web storage.

Sharing files

Select a device or web storage, tap , select files, tap **Done**, and then select a sharing method.

Playing files on a remote device

Select a device or web storage, tap , select a file, and then select a device.





- Supported file formats may differ depending on connected devices as a media player.
- Some files may be buffered while playing depending on the network connection.

Managing contents on a web storage service

Select a web storage service, and then view and manage your files.

To download files from a web storage service, tap , select files, and then tap **Done**.

To register web storage services to the device, tap  → **Settings** → **Registered storage** → , and then select a web storage service.

Group Play

Use this application to share screens with multiple devices. Create or join a Group Play session, and then share images, documents, or music.

Tap **Group Play** on the Applications screen.



This application may not be available depending on the region or service provider.



Creating a group for Group Play

Tap **Create group**, set a password, and then use the following features:

- **Share music:** Select music files to share. You can connect two or more devices and use them to achieve a surround sound effect.
- **Share pictures:** Select images to share.
- **Share documents:** Select documents to share.
- **Play games:** Play online games with friends.

Tap  and write a note or draw on the screen. All participants can see what you create.

Tap  to view all shared images in mosaic layout.

Tap  or  to select more images or documents.

Tap  to view the group participants.

Joining Group Play

Tap **Join group**, select a Group Play session to join, and then enter the password for the group. Select a media category and the content that is currently being shared will appear on the device.

WatchON

Use this application to connect to a TV to watch your favourite shows and movies.

Tap **WatchON** on the Applications screen.

You must first connect the device to a network and ensure that the device's infrared port is facing the TV.



This application may not be available depending on the region or service provider.

Connecting to a TV

Connect to a TV to display the device's screen onto a large surface and control the TV remotely with the device.

Tap  → **Continue**, and then follow the on-screen instructions to register the TV to the device. The steps vary depending on the options you choose.

Watching TV

Select from the TV programme suggestions or select a category at the bottom of the screen. Select a TV programme and then tap **Watch on TV** or **Watch now**. The selected programme will show up on the connected TV.

Tap  and open the control panel to control the TV.

Setting programme reminders

Tap **Timeline** at the bottom of the screen and select a time for a TV programme you want to watch. Select a programme, and then tap **Set reminder**. The reminder for the selected programme is added to **S Planner**.

Smart Remote

Use this application to use the device as a remote control for TVs and entertainment systems.

Tap **Smart Remote** on the Applications screen.

You must first connect the device to a Wi-Fi network and ensure that the device's infrared port is facing the TV.



This application may not be available depending on the region or service provider.

Setting the device as a remote control for a TV

Tap **Choose Your Country or Region**, select a country or a region, and then follow on-screen instructions to complete the setup process.

To open the remote control panel, tap the panel handle at the bottom right edge of the screen.

To add another room, tap  → **Add New Room**.

Customising remote control settings

Tap  and use the following options:

- **Edit Channels:** Edit channels displayed on the device's screen.
- **Rooms & Devices:** Change connection settings.
- **Profile:** Enter a user profile so that Peel can find top picks.
- **Favorite Programs:** View favourite programmes.
- **Cut Programs:** Restore previously hidden programmes.
- **Genres:** Hide or change the order of genres.
- **Sports:** Hide or change the order of sports.
- **Send Feedback:** Report your opinions for application development.
- **Notifications:** Set the device to remind you of various upcoming TV programmes.
- **Reset Peel:** Reset the connection settings.

Media

Music Player

Use this application to listen to music.

Tap **Music Player** on the Applications screen.





- Some file formats are not supported depending on the device's software version.
- Some files may not play properly depending on the encoding method used.

Playing music

Select a music category, and then select a song to play.

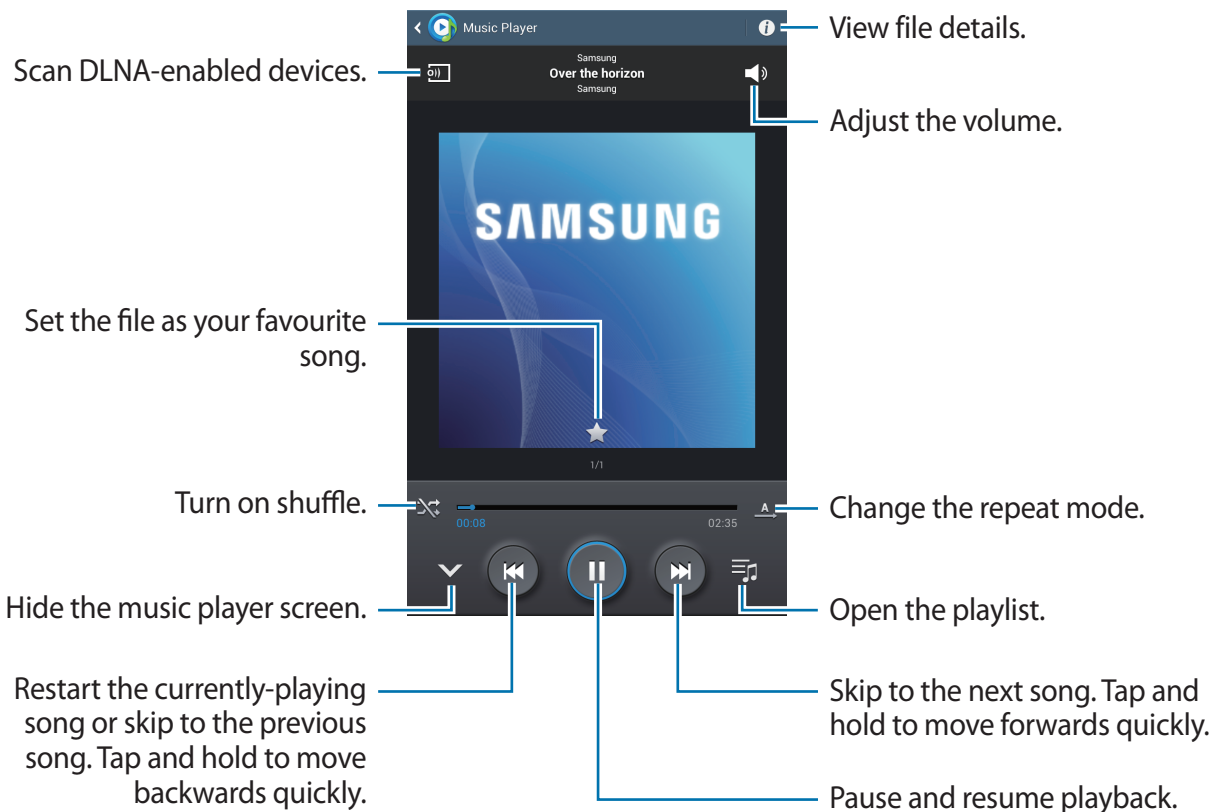
Tap the album image at the bottom of the screen to open the music player screen.



To set a personalised sound while listening to songs with a headset, tap  → **Settings** → **Advanced** → **Adapt Sound** → **On**. When you turn the volume up to level 14 or higher, the adapt sound option is not applied to music playback. If you turn the volume down to level 13 or lower, the option is reapplied.

Creating playlists

Make an own selection of songs.

Tap  → **Create playlist**. Enter a title and tap **OK**. Select songs to include, and then tap **Done**.

To add the currently-playing song to a playlist, tap  → **Add to playlist**.

Playing music by mood

Play music grouped by mood. The playlist is automatically created by the device. When a new song is added, tap **Music square** → .

Tap **Music square** and select a cell of mood. Or select multiple cells by dragging your finger.

Camera

Use this application to take photos or videos.

Use **Gallery** to view photos and videos taken with the device's camera. (p. 61)

Tap **Camera** on the Applications screen.



- The camera automatically shuts off when unused.
- Make sure that the lens is clean. Otherwise, the device may not work properly in some modes that require high resolutions.

Camera etiquette

- Do not take photos or videos of other people without their permission.
- Do not take photos or videos where legally prohibited.
- Do not take photos or videos in places where you may violate other people's privacy.

Taking photos

Taking a photo

Tap the image on the preview screen where the camera should focus. When the subject is in focus, the focus frame turns green. Tap  to take the photo.



Shooting mode

Several photo effects are available.

Tap **MODE**, and then scroll up or down the screen at the right side of the screen.

- **Auto:** Use this to allow the camera to evaluate the surroundings and determine the ideal mode for the photo.
- **Beauty face:** Take a photo with lightened faces for gentler images.
- **Sound & shot:** Use this to take a photo with sound.

Tap  to take a photo. The device records a few seconds of audio after taking a photo.





While taking photos in this mode, sound is recorded by the internal microphone.

- **Panorama:** Take a photo composed of many photos strung together.
To get the best shot, follow these tips.
 - Move the camera slowly in one direction.
 - Keep the camera's viewfinder within the guidelines.
 - Avoid taking photos of a subject in front of unrecognisable backgrounds, such as empty skies or plain walls.
- **Sports:** Use this setting for fast-moving subjects.
- **Night:** Use this setting for images taken in darker conditions.

Panoramic photos

A panoramic photo is a wide landscape image consisting of multiple shots.

Tap **MODE** → **Panorama**.

Tap  and move the camera in any direction. When two panorama guide frames are aligned, the camera automatically takes another shot in a panoramic sequence. To stop shooting, tap .

Taking videos

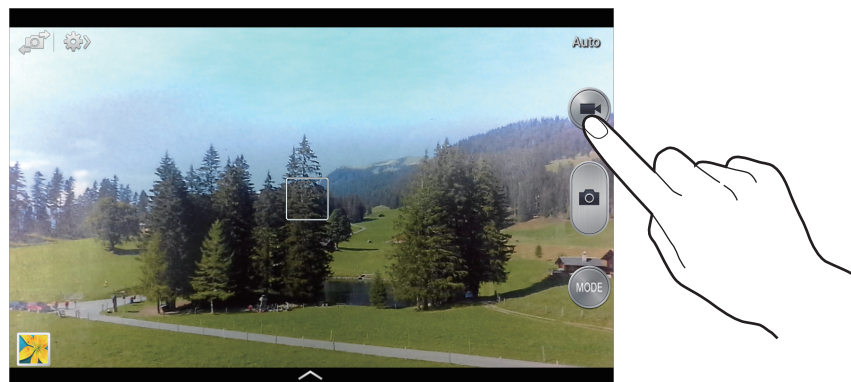

Taking a video

Tap . To pause recording, tap . To stop recording, tap .



The zoom function may not be available when recording at the highest resolution.

Recording mode

Tap  →  to change recording mode.

- **Normal:** Use this mode for normal quality.
- **Limit for Email:** Use this mode to lower quality for sending via email.

Zooming in and out

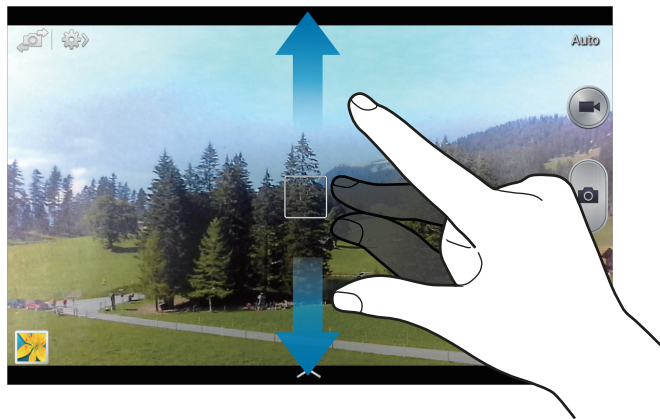

Use one of the following methods:

- Use the Volume button to zoom in or out.
- Spread two fingers apart on the screen to zoom in, and pinch to zoom out.



- The zoom function may not be available when shooting at the highest resolution.
- The zoom in/out effect is available when using the zoom feature while shooting video.



Share shot

Tap  → , and then select one of the following:



- **Share shot:** Send a photo directly to another device via Wi-Fi Direct.
- **Buddy photo share:** Set the device to recognise a person's face that you have tagged in a photo and send it to that person.
- **ChatON photo share:** Send a photo to another device via ChatON.
- **Remote viewfinder:** Set a device to control the camera remotely.

Controlling the camera remotely

Set a device as a viewfinder to control the camera remotely.

Tap  →  → **Remote viewfinder**, and then connect the device and the camera using Wi-Fi Direct. Tap  to take a photo remotely using the device as a viewfinder.

Configuring settings for Camera

Tap  →  to configure settings for Camera. Not all of the following options are available in both still camera and video camera modes. The available options vary depending on the mode used.

- **Photo size / Video size:** Select a resolution. Use higher resolution for higher quality. But it takes up more memory.
- **Metering:** Select a metering method. This determines how light values are calculated. **Centre-weighted** measures background light in the centre of the scene. **Spot** measures the light value at a specific location. **Matrix** averages the entire scene.
- **ISO:** Select an ISO value. This controls camera light sensitivity. It is measured in film-camera equivalents. Low values are for stationary or brightly-lit objects. Higher values are for fast-moving or poorly-lit objects.

- **Focus mode:** Select a focus mode. **Auto focus** is camera-controlled. **Macro** is for very close objects.
- **GPS tag:** Attach a GPS location tag to the photo. Activate this feature when taking photos to create albums in **Story Album**.



- To improve GPS signals, avoid shooting in locations where the signal may be obstructed, such as between buildings or in low-lying areas, or in poor weather conditions.
 - Your location may appear on your photos when you upload them to the Internet. To avoid this, deactivate the GPS tag setting.
- **Review:** Briefly display photos taken.
 - **Volume key:** Set the device to use the Volume button to control the shutter or zoom function.
 - **Timer:** Use this for delayed-time shots.
 - **White balance:** Select an appropriate white balance, so images have a true-to-life colour range. The settings are designed for specific lighting situations. These settings are similar to the heat range for white-balance exposure in professional cameras.
 - **Exposure value:** Change the exposure value. This determines how much light the camera's sensor receives. For low-light situations, use a higher exposure.
 - **Guidelines:** Display viewfinder guides to help composition when selecting subjects.
 - **Voice control:** Set the camera to take photos with voice commands.
 - **Contextual filename:** Set the camera to display contextual tags. Activate this to use Tag Buddy in **Gallery** and **Story Album**.
 - **Save as flipped:** Invert the image to create a mirror-image of the original scene.
 - **Storage:** Select the memory location for storage.
 - **Reset:** Reset the camera settings.

Shortcuts

Reorganise shortcuts for easy access to the camera's various options.

Tap  → **Edit quick settings**.

Tap and hold an option and drag it to a slot at the top of the screen. The other icons can be moved within the list by tapping and dragging them.

Gallery

Use this application to view images and videos.

Tap **Gallery** on the Applications screen.



- Some file formats are not supported depending on the software installed on the device.
- Some files may not play properly depending on the encoding method used.

Viewing images

Launching **Gallery** displays available folders. When another application, such as **Email**, saves an image, the **Download** folder is automatically created to contain the image. Likewise, capturing a screenshot automatically creates the **Screenshots** folder. Select a folder to open it.

In a folder, images are displayed by creation date. Select an image to view it in full screen.

Scroll left or right to view the next or previous image.

Zooming in and out

Use one of the following methods to zoom in an image:

- Double-tap anywhere to zoom in.
- Spread two fingers apart on any place to zoom in. Pinch to zoom out, or double-tap to return.

Playing videos

Video files show the  icon on the preview. Select a video to watch it and tap .

Editing images

When viewing an image, tap  and use the following functions:



- **Favourite:** Add the image to favourites.
- **Slideshow:** Start a slideshow with the images in the current folder.
- **Photo frame:** Use this to add a frame and a note to an image. The edited image is saved in the **Photo frame** folder.
- **Photo note:** Use this to write a note on the back of the image. Tap  to edit the note.
- **Copy to clipboard:** Copy to clipboard.
- **Print:** Print the image via a USB or Wi-Fi connection.
- **Rename:** Rename the file.
- **Buddy photo share:** Send the image to a person whose face is tagged in the image.
- **Rotate left:** Rotate anticlockwise.
- **Rotate right:** Rotate clockwise.
- **Crop:** Resize the blue frame to crop and save the image in it.
- **Scan for nearby devices:** Search for devices that have media sharing activated.
- **Set as:** Set the image as a wallpaper or a contact image.
- **Details:** View image details.
- **Settings:** Change the Gallery settings.

Favourite images

When viewing an image, tap  → **Favourite** to add the image to the favourites list.



Deleting images

Use one of the following methods:

- In a folder, tap  → **Select item**, select images by ticking, and then tap .
- When viewing an image, tap .

Sharing images

Use one of the following methods:

- In a folder, tap  → **Select item**, select images by ticking, and then tap  to send them to others.
- When viewing an image, tap  to send it to others or share it via social network services.

Setting as wallpaper

When viewing an image, tap  → **Set as** to set the image as wallpaper or to assign it to a contact.

Tagging faces

Tap  → **Settings** → **Tags**, and then tick **Face tag**. A yellow frame appears around the recognised face on an image. Tap the face, tap **Add name**, and then select or add a contact.

When the face tag appears on an image, tap the face tag and use available options, such as sending messages.



Face recognition may fail depending on the face angle, face size, skin colour, facial expression, light conditions, or accessories the subject is wearing.

Using Tag Buddy

Tap  → **Settings** → **Tags** → **Tag buddy**, and then drag the **Tag buddy** switch to the right to display a contextual tag (weather, location, date, and person's name) when opening an image.

Organising with folders

Create a folder to organise images or videos stored in the device. You can copy or move files from one folder to another.

To create a new folder, tap . Enter a name for the folder, tap **OK**, and then tick images or videos. Tap and hold any selected image or video, drag it to the new folder, and then tap **Done**. Tap **Copy** to copy or **Move** to move.

Story Album

Use this application to create your own digital album to keep your stories by organising the images neatly and automatically.

Tap **Story Album** on the Applications screen.

Creating story albums

Tap **Create album** → **By tag information** to create a story album automatically. Select criteria, and then tap **Find pictures**. Enter a title for the album, select a theme, and then tap **Create album**.

To create it manually, tap **Create album** → **From the Gallery**.

Creating recommended albums

When you take photos at one location, the device automatically sorts your photos into albums based on your specified criteria and suggests making the new albums.

Tap  → **Settings** → **Suggestions** → **Home city**, and then set a method for recognising your location. Select an album type and set a minimum number of photos.

When you take photos that meet the criteria you set, the device will suggest making an album.

Tap **Create album** → **From suggestions**. Select an album, enter a title for the album, and then tap **Done** → **OK**.



The device will recommend making story albums when you surpass the preset number of photos in a single day.

Viewing story albums

Select a story album. The cover image appears on the first page. Scroll left or right to view images in the story album.

When viewing an image, tap  and use the following functions:

- **Add content:** Add more content to the current page.
- **Remove content:** Delete content on the current page.
- **Change theme:** Change the theme for the page layout.
- **Slideshow:** Start a slideshow with the images in the current album.
- **Share via:** Send the album to others.
- **Print:** Print the album via a USB or Wi-Fi connection.
- **Order photo book:** Place an order for a printed album.
- **Export Album:** Export the album to other storage locations.
- **Delete album:** Delete the album.

Editing images

Tap the image of the page in an album.

To add a caption, tap .

To send the image to others, tap .

To delete the image, tap .

To apply effects to the image, tap .

To start a slideshow, tap  → **Slideshow** → **Start slideshow**.

To set the image as an album cover image, tap  → **Set as cover**.

To rotate the image anticlockwise, tap  → **Rotate left**.

To rotate the image clockwise, tap  → **Rotate right**.

Paper Artist

Use this application to make images look like illustrations with fun effects or frames.

Tap **Paper Artist** on the Applications screen.

Use artistic tools to edit an image. The edited image is saved in the **Gallery** → **Paper Pictures** folder.

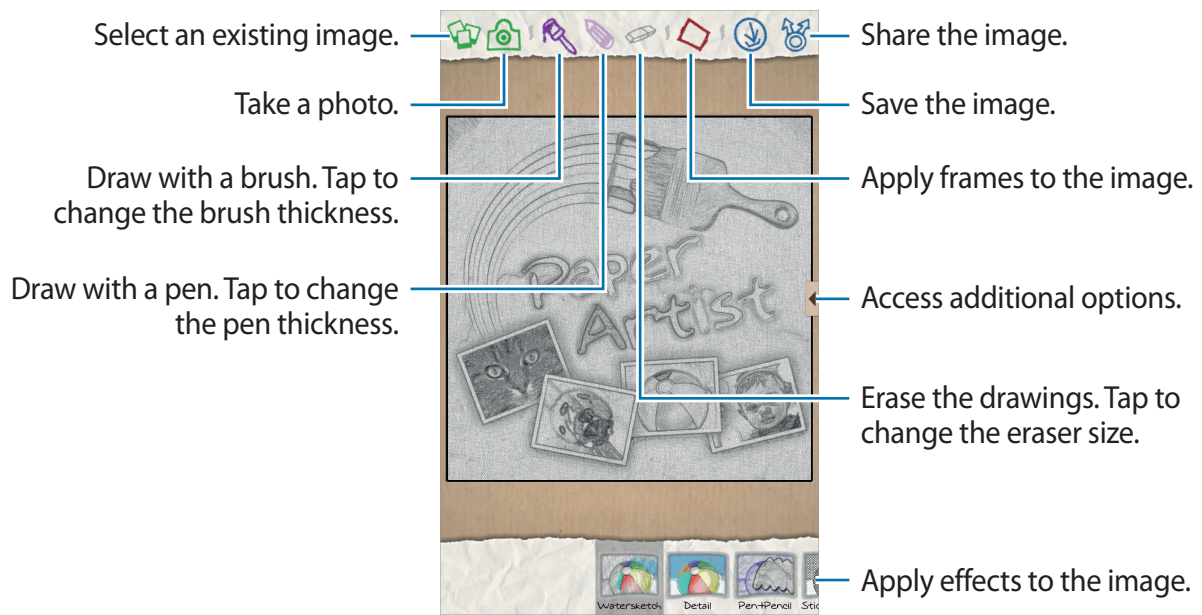

Video Player

Use this application to play video files.

Tap **Video Player** on the Applications screen.



- Avoid locking the device's screen while playing a DivX Video-On-Demand. Each time you lock the screen while playing a DivX Video-On-Demand, one of your available rental counts is lost.
- Some file formats are not supported depending on the device's software.
- Some files may not play properly depending on the encoding method used.

Playing videos

Select a video to play.



Deleting videos

Tap  → **Delete**, select videos by ticking, and then tap **Delete**.

Sharing videos

Tap  → **Share via**, select a sharing method, select videos by ticking, and then tap **Share**.

Using Popup Video player

Use this feature to use other applications without closing the video player. While watching videos, tap  to use the pop-up player.

Spread two fingers apart on the screen to enlarge the player or pinch to reduce it. To move the player, drag the player to another location.

YouTube

Use this application to watch videos from the YouTube website.

Tap **YouTube** on the Applications screen.



This application may not be available depending on the region or service provider.

Watching videos

Tap , and then enter a keyword. Select one of the returned search results to watch a video.

Rotate the device to landscape orientation to display full screen.

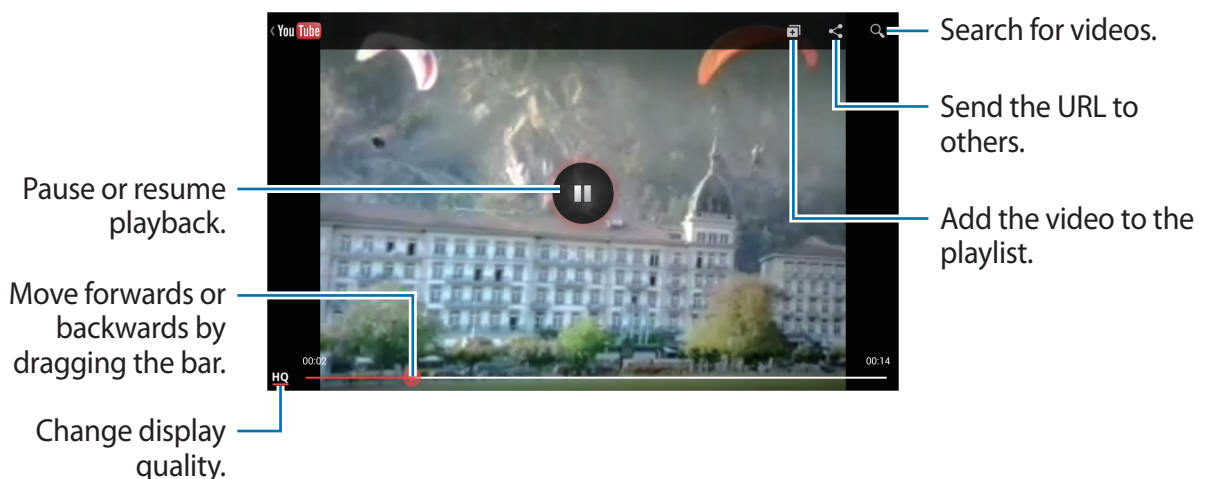

Sharing videos

Select the video to view, tap , and then select a sharing method.

Uploading videos

Select your account, tap , select a video, enter information for the video, and then tap **UPLOAD**.

Flipboard

Use this application to access your personalised magazines.

Tap **Flipboard** on the Applications screen.



This application may not be available depending on the region or service provider.

To start your Flipboard, flick left on the greeting page, select news topics, and then tap **Build Your Flipboard**.

Select a cover story or a topic, flick through the Flipboard pages, and then select an article to read.

While reading an article, use the following icons:

-  : Go to the previous page.
-  : View others' comments about the article.
-  : Share the article via Twitter.
-  : Share the article with others.
-  : Set the article as your likes in Facebook.
-  : Add the article to the favourites list in Twitter.
-  : Add the article to your Flipboard magazine.

Application & media stores

Play Store

Use this application to purchase and download applications and games that are able to run on the device.

Tap **Play Store** on the Applications screen.



This application may not be available depending on the region or service provider.

Installing applications

Browse applications by category, or tap  to search with a keyword.

Select an application to view information. To download it, tap **Install**. If there is a charge for the application, tap the price, and follow on-screen instructions to complete the purchase process.



- When a new version is available for any installed application, an update icon appears at the top of the screen to alert you to the update. Open the notifications panel and tap the icon to update the application.
- To install applications that you downloaded from other sources, on the Applications screen, tap **Settings** → **Security** → **Unknown sources**.

Uninstalling applications

Uninstall the applications purchased from **Play Store**.

Tap , select an application to delete in the list of installed applications, and then tap **Uninstall**.

Samsung Apps

Use this application to purchase and download dedicated Samsung applications. For more information, visit www.samsungapps.com.

Tap **Samsung Apps** on the Applications screen.



This application may not be available depending on the region or service provider.

Installing applications

Browse applications by category. Tap  to select a category.

To search for an application, tap  at the top of the screen, and then enter a keyword in the search field.

Select an application to view information. To download it, tap **Get** or **Buy**.



When a new version is available for any installed application, an update icon appears at the top of the screen to alert you to the update. Open the notifications panel and tap the icon to update the application.

Game Hub

Use this application to access games.

Tap **Game Hub** on the Applications screen.



This application may not be available depending on the region or service provider.

Scroll left or right and select a game to download from **Samsung Apps**.

Music Hub

Use this application to play music and purchase songs or albums from the Music Hub catalogue.

Subscribe to the Music Hub premium service to enjoy customised recommendations, unlimited song streaming, personal radio stations, and cloud storage service for all your music.

To get more details, tap  → **Help** or visit the Music Hub website.

Tap **Music Hub** on the Applications screen.



- This application may not be available depending on the region or service provider.
- Some features may be labelled differently depending on the subscription terms.
- Some features including streaming services may not be available depending on the region or service provider.

MY MUSIC

Play music stored on the device and in the cloud storage server. All your music stays automatically synced with your computer.

STORE

Enjoy unlimited song streaming. Stream songs or download them to listen without network coverage. Add songs to playlists and share them with friends.

RADIO

Listen to music on radio stations or create your own one. You can personalise your station based on an artist you like. The station will play music similar to the songs of your favourite artist. You can also receive customised recommendations from Music Hub.

Play Books

Use this application to read and download book files.

Tap **Play Books** on the Applications screen.



This application may not be available depending on the region or service provider.

Play Movies

Use this application to watch, download, and rent movies or TV shows.

Tap **Play Movies** on the Applications screen.



This application may not be available depending on the region or service provider.

Play Music

Use this application to listen to music from the device or stream music from the Google cloud service.

Tap **Play Music** on the Applications screen.



This application may not be available depending on the region or service provider.

Readers Hub

Use this application to download and read book files.

Tap **Readers Hub** on the Applications screen.



This application may not be available depending on the region or service provider.

Select a book to read. To download book files, go to the Readers Hub Store.

Learning Hub

Use this application to access learning material.

Tap **Learning Hub** on the Applications screen.



This application may not be available depending on the region or service provider.

Select a category, and then select a video lecture or book.

Utilities

Memo

Use this application to record important information to save and view at a later date.

Tap **Memo** on the Applications screen.

Composing memos

Tap , enter a memo, and then tap **Save**.

To change the background colour, tap  → **Colour**.

To lock the memo so that others cannot view it, tap  → **Lock**.

Browsing memos

Browse memo thumbnails by scrolling up or down.

To edit the memo, tap the memo.

To search for a memo, tap .

To change the view mode, tap .

To delete memos, tap .

To sort memos by date, tap  → **Sort by**.

To send the text in memos to others, tap  → **Share text via**.

To send memos to others, tap  → **Share via**.

To print memos via a USB or Wi-Fi connection, tap  → **Print**.

To import memos from Google Docs, tap  → **Import**.

To export memos to other storage locations, tap  → **Export**.

To change the memo settings, tap  → **Settings**.

Viewing a memo

Tap the memo thumbnail to open it. Scroll left or right to see more memos.

Tap  and use the following:

- **Delete:** Delete the memo.
- **Colour:** Change the background colour.
- **Lock:** Lock the memo so that others cannot view it.
- **Print:** Print the memo via a USB or Wi-Fi connection.
- **Share text via:** Send the text in the memo to others.
- **Share via:** Send the memo to others.

S Planner

Use this application to manage events and tasks.

Tap **S Planner** on the Applications screen.

Creating events or tasks

Tap , and then use one of the following methods:

- **Add event:** Enter an event with an optional repeat setting.
- **Add task:** Enter a task with an optional priority setting.
- **Add memo:** Create a handwritten memo to attach to the date.

To add an event or task more briefly, tap a date to select it and tap it again.

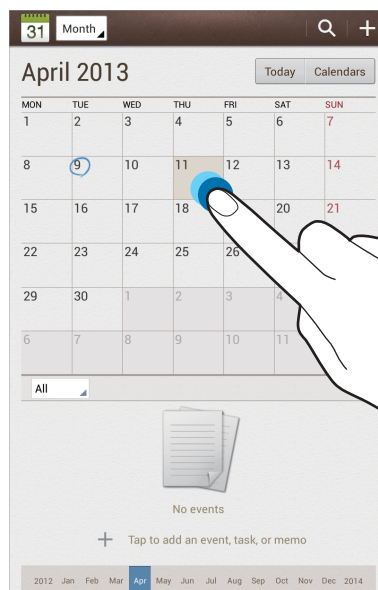

Enter a title and specify which calendar to use or sync with. Then tap **Edit event details** or **Edit task details** to add more details, such as how often the event repeats, when it has an advance alert, or where it takes place.

Invite others to the event by sending an email. Enter the email address to the **Participants** field, or tap  to open the contacts list.

Attach a map showing the location of the event. Enter the location in the **Location** field, tap  next to the field, and then pinpoint the precise location by tapping and holding on the map that appears.

Attach an image. Tap **Images**, and then take a photo or select one of the existing images.

Syncing with Google Calendar

On the Applications screen, tap **Settings** → **Google** under **Accounts**, select the Google account, and then tick **Sync Calendar**. To manually sync for updating, on the Applications screen, tap **S Planner** →  → **Sync**.

To display synced event or task, tap  → **Settings** → **View settings** → **Calendars** → **Display**, select the Google account, and then tap **OK**.

Changing calendar type

Tap the top left of the screen, and then select one from among different types of calendars including month, week, and others. A pinch gesture can be used to change calendar type. For example, pinch to change from the monthly calendar to the yearly calendar, and spread apart to change yearly calendar back to monthly calendar.

Searching for events

Tap , and then enter a keyword to search for.

To view today's events, tap **Today** at the top of the screen.

Deleting events

Select a date, and then tap  → **Delete**.

Sharing events

Select an event, tap  → **Share via**, and then select a sharing method.

Dropbox



Use this application to save and share files with others via the Dropbox cloud storage. When you save files to Dropbox, your device automatically syncs with the web server and any other computers that have Dropbox installed.

Tap **Dropbox** on the Applications screen.





This application may not be available depending on the region or service provider.

When running Dropbox for the first time, tap **Start** to activate it. Follow the on-screen instructions to complete the setup.

Once Dropbox is activated, photos and videos taken with the device's camera are uploaded to Dropbox automatically. To view the uploaded photos or videos, tap . To share or delete files or create albums, tap , and then select files.

To upload files to Dropbox, tap  →  → **Upload here** → **Photos or videos** or **Other files**. To open files in Dropbox, select a file.

While viewing images or videos, tap  to add it to the favourites list. To open files in the favourites list, tap .

Cloud

Use this feature to sync files or back up settings and application data with your Samsung account or Dropbox.

On the Applications screen, tap **Settings** → **Cloud**.



This feature may not be available depending on the region or service provider.

Syncing with the Samsung account

Tap your Samsung account or **Sync settings** to sync files.

Backing up or restoring data

Tap **Backup** to back up or restore data with your Samsung account.

Syncing with Dropbox

Tap **Link Dropbox account**, and then enter the Dropbox account. Follow the on-screen instructions to complete the setup.

Once you sign in, tap **Allow** and the device automatically syncs files with Dropbox whenever you make some changes.

Polaris Office

Use this application to edit documents in various formats, including spreadsheets and presentations.

Tap **Polaris Office** on the Applications screen.



Some functions may not be available, depending on the file type.

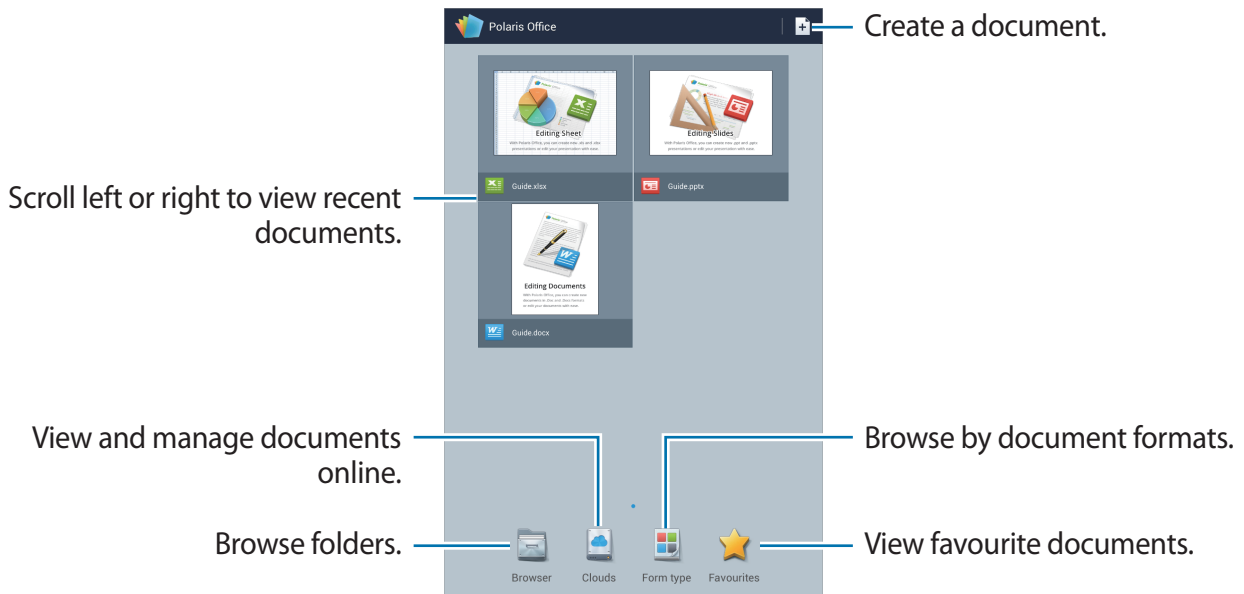

Creating documents

Tap , and then select a document type.

Use the editing toolbar at the top of the screen to edit the document.

To finish, tap  → **Save**, enter a filename, select a folder to save to, and then tap **Save**.

Reading documents

Tap a file. Or tap **Browser**, **Clouds**, **Form type**, or **Favourites**, and then select a file to open.

To start a slideshow, tap  → **Slide Show**.

To search for a text string in the document, tap .

Tap , and then use one of the following functions:

Document

- **Save as:** Save the document with a different name.
- **PDF export:** Save the document as a PDF file.
- **Find & Replace:** Search for or replace text.
- **Page layout:** Change the layout of pages.
- **Full width view:** View the document contents only, without margins.
- **Zoom:** Change the view size.
- **Reflow text:** Rearrange the text to fit the screen.
- **View Comment:** View comments in the document.
- **TTS:** Read the document via the text-to-speech feature.
- **Print:** Print the document via a USB or Wi-Fi connection.

Presentation

- **Slide Show:** Start a slideshow.
- **Save as:** Save the document with a different name.
- **PDF export:** Save the document as a PDF file.
- **Find & Replace:** Search for or replace text.
- **Single slide view:** View slides one by one.
- **Zoom:** Change the view size.
- **Print:** Print the document via a USB or Wi-Fi connection.

Spreadsheet

- **Save as:** Save the document with a different name.
- **Find & Replace:** Search for or replace text.
- **Protect worksheet:** Lock the sheet so that others cannot edit it.
- **Freeze frame:** Keep the selected row in place.
- **Recalculation:** Recalculate the functions on the sheet.
- **Sort:** Sort cells by specific criteria.
- **Filter:** View cells filtered by specific criteria.
- **Zoom:** Change the view size.
- **Print:** Print the document via a USB or Wi-Fi connection.

Text

- **Save as:** Save the document with a different name.
- **TTS:** Read the document via the text-to-speech feature.
- **Print:** Print the document via a USB or Wi-Fi connection.

Alarm

Use this application to set wake-up calls and alarms for important events.

Tap **Alarm** on the Applications screen.

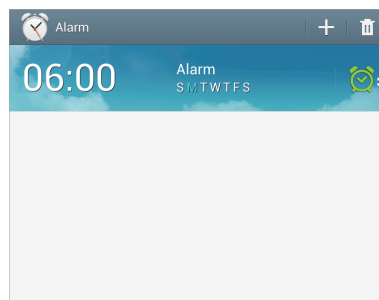



Turn this alarm on or off.

Setting alarms

Tap , set a time for the alarm to go off, select days for the alarm to repeat, and then tap **Save**.

- **Location alarm:** Set a location. The alarm goes off only when you are in the location.
- **Snooze:** Set an interval and the number of times for the alarm to repeat after the preset time.
- **Smart alarm:** Set a time for the alarm to go off before the preset time.

Stopping alarms

Drag  outside the large circle to stop an alarm. Drag  outside the large circle to repeat the alarm after a specified length of time.

Deleting alarms

Tap and hold the alarm, and then tap **Delete**.

World Clock

Use this application to check the time in any location in the world.

Tap **World Clock** on the Applications screen.

Creating clocks

Tap , enter a city name or select a city from the globe, and then tap .

To apply summer time, tap and hold a clock, and then tap **DST settings**.

Deleting clocks

Tap , select clocks, and then tap **Delete**.

Calculator

Use this application for simple or complex calculations.

Tap **Calculator** on the Applications screen.

Rotate the device to landscape orientation to display the scientific calculator. If **Screen rotation** is disabled, tap  → **Scientific calculator**.

To see the calculation history, tap  to hide the keypad.

To clear the history, tap  → **Clear history**.

To change the character size for the history, tap  → **Text size**.

S Translator

Use this application to translate text into other languages.

Tap **S Translator** on the Applications screen.

Using S Translator

Set the source and target languages, enter text in the input field, and then tap .

To add a language pair to your favourites list, tap .

To send a language pair to others, tap .

Starting a conversation with the translator

Tap the buttons at the bottom of the screen to communicate with another person via spoken translation.

Tap **Speak** for your language, and then speak into the microphone. The device will translate what you say. Tap  in the target language field to let the device read the translation out loud.

Then, tap **Speak** for the language of the person you are talking with and let the person reply in their language. The device will translate what they say. Tap  in the source language field to let the device read it back to you.

S Voice

Use this application to command the device by voice to send a message, write a memo, and more.

Tap **S Voice** on the Applications screen. Alternatively, press the Home button twice.



This application may not be available depending on the region or service provider.

Here are several examples of spoken commands:

- Open music
- Launch calculator
- Check schedule

Tips for better voice recognition

- Speak clearly.
- Speak in quiet places.
- Do not use offensive or slang words.
- Avoid speaking in dialectal accents.

The device may not recognise your commands or may perform unwanted commands depending on your surroundings or how you speak.

Google

Use this application to search not only the Internet, but also applications and their contents on the device as well.

Tap **Google** on the Applications screen.



This application may not be available depending on the region or service provider.

Searching the device

Tap the search field, and then enter a keyword. Alternatively, tap , and then speak a keyword.

If no results are returned from the applications, the web browser appears, displaying the search results.

Searching with images

To search with an image, tap  → **Search with camera**. Aim the camera at an image, and then tap .



This feature is available only for English.

Search scope

To select what applications to search, tap  → **Settings** → **Tablet search**, and then tick the items to search for.

Google Now

Launch Google search to view Google Now cards that show the current weather, public transit info, your next appointment, and more when you are most likely to need it.

Join Google Now when opening Google search for the first time. To change Google Now settings, tap  → **Settings** → **Google Now**.

Voice Search

Use this application to search webpages by speaking.

Tap **Voice Search** on the Applications screen.





This application may not be available depending on the region or service provider.

Speak a keyword or phrase when **Speak now** appears on the screen.



My Files

Use this application to access all kinds of files stored in the device, including images, videos, songs, and sound clips.







Tap **My Files** on the Applications screen.

Select a folder to open it. To go back to the parent folder, tap . To return to the root directory, tap .

In a folder, use one of the following functions:

-  : Search for files.
-  : Change the view mode.
-  : Create a folder.
- **Time**: Sort files or folders.

Select a file or folder by ticking, and then use one of the following functions:

-  : Copy files or folders to another folder.
-  : Move files or folders to another folder.
-  : Delete files or folders.
-  : Send files to others.
-  → **Rename**: Rename a file or folder.
-  → **Details**: View file or folder details.

Downloads

Use this application to see what files are downloaded through the applications.

Tap **Downloads** on the Applications screen.



This application may not be available depending on the region or service provider.

To see the files downloaded from the Internet, tap **Internet downloads**, otherwise, tap **Other downloads** to see the files downloaded from other applications, such as **Email**.

Select a file to open it with an appropriate application.

To sort the files by size, tap **Sort by size**.

To sort the files by date, tap **Sort by date**.

TripAdvisor

Use this application to get travel information such as destination or hotel. You can also book for a room and share your reviews with others.

Tap **TripAdvisor** on the Applications screen.

Travel & local



Maps

Use this application to pinpoint the location of the device, search for places, or get directions. Tap **Maps** on the Applications screen.



This application may not be available depending on the region or service provider.

Searching for locations

Tap **Search Maps**, enter an address, and then tap . Select a location to view the detailed location information. To search for nearby locations, tap  → **Local**.



Once the location is found, tap  and use one of the following functions:

- **Clear Map:** Clear the map.
- **Make available offline:** Save the map of a specified area to view it offline.
- **Local:** Search for nearby locations.
- **Layers:** Overlay multiple layers including satellite images, traffic information, and more.
- **Latitude:** Share location information with friends.
- **My Places:** View offline maps, starred places, recent places, and more.
- **Settings:** Change the map settings.
- **Help:** View information about using the map.

To view current location, tap .

To zoom in or out the map, spread two fingers apart on the screen to zoom in, and pinch to zoom out.

Getting directions for a destination

- 1 Tap .
- 2 Tap , and then select a method to enter starting and ending locations:
 - **My current location:** Use current location for starting location.
 - **Contacts:** Select from the contacts list.
 - **Point on map:** Pinpoint by tapping on the map.
 - **My Places:** Select from the list of favourite places.
- 3 Select a travel method, such as driving, public transit, or walking, and then tap **Go**.
- 4 Select one of the routes that appear.

Local

Use this application to search for nearby restaurants, banks, bus stops, and more.

Tap **Local** on the Applications screen.



This application may not be available depending on the region or service provider.

Select a place category, and then select a place from the list of search results.

- **Map:** Pinpoint the place on the map.
- **Directions:** Search for a route to the place.

To add a place category, tap  → **Add a search** on the category list, enter a keyword to search into the text field.

Navigation

Use this application to search for a route to a destination.

Tap **Navigation** on the Applications screen.



- Navigation maps, your current location, and other navigational data may differ from actual location information. You should always pay attention to road conditions, traffic, and any other factors that may affect your driving. Follow all safety warnings and regulations while driving.
- This application may not be available depending on the region or service provider.

Specify the destination by using various methods, such as speaking or entering the destination address. Once a route is found, follow the on-screen instructions to navigate to the destination.

Settings

About Settings

Use this application to configure the device, set application options, and add accounts. Tap **Settings** on the Applications screen.

Wi-Fi

Activate the Wi-Fi feature to connect to a Wi-Fi network and access the Internet or other network devices.

To use options, tap .

- **Advanced:** Customise Wi-Fi settings.
- **WPS push button:** Connect to a secured Wi-Fi network with a WPS button.
- **WPS PIN entry:** Connect to a secured Wi-Fi network with a WPS PIN.
- **Help:** Access help information for Wi-Fi.

Setting Wi-Fi sleep policy

On the Settings screen, tap **Wi-Fi** →  → **Advanced** → **Keep Wi-Fi on during sleep**.

Setting Network notification

The device can detect open Wi-Fi networks and display an icon on the status bar to notify when available.

On the Settings screen, tap **Wi-Fi** →  → **Advanced** and tick **Network notification** to activate this feature.

Wi-Fi Direct

Wi-Fi Direct connects two devices directly via a Wi-Fi network without requiring an access point.

On the Settings screen, tap **Wi-Fi** → **Wi-Fi Direct**.

Bluetooth

Activate the Bluetooth feature to exchange information over short distances.

To use more options, tap .

- **Visibility timeout:** Set duration that the device is visible.
- **Received files:** View received files via the Bluetooth feature.
- **Help:** Access help information for Bluetooth.

Data usage

Keep track of your data usage amount.

More settings

Customise settings to control connections with other devices or networks.

Flight mode

This disables all wireless functions on your device. You can use only non-network services.

VPN

Set up and connect to virtual private networks (VPNs).

Nearby devices

- **File sharing:** Activate media sharing to allow other DLNA-enabled devices to access media files on your device.
- **Shared contents:** Set the device to share your content with other devices.
- **Allowed devices list:** View the list of devices that can access your device.
- **Not-allowed devices list:** View the list of devices that are blocked from accessing your device.
- **Download to:** Select a memory location for saving media files.
- **Upload from other devices:** Set the device to accept uploads from other devices.

Screen Mirroring

Activate the screen mirroring feature and share your display with others.

Kies via Wi-Fi

Connect the device to Samsung Kies via a Wi-Fi network.

Blocking mode

Select which notifications will be blocked and how long to block them.

Driving mode

Activate driving mode to set the device to read contents aloud and specify applications to use in driving mode.

Sound

Change settings for various sounds on the device.

- **Volume:** Adjust the volume level for music and videos, system sounds, and notifications.
- **Default notification sound:** Select a ringtone for events, such as incoming messages.
- **Touch sounds:** Set the device to sound when selecting an application or option on the touch screen.
- **Screen lock sound:** Set the device to sound when locking or unlocking the touch screen.
- **Adapt Sound:** Personalise the sound for the ear you use most while listening to music.

Display

Change the settings for the display.

- **Wallpaper:**
 - **Home screen:** Select a background image for the Home screen.
 - **Lock screen:** Select a background image for the locked screen.
 - **Home and lock screens:** Select a background image for the Home screen and the locked screen.
- **Notification panel:** Customise the items that appear on the notifications panel.
- **Multi window:** Set the device to use Multi Window.
- **Screen mode:**
 - **Adapt display:** Use this mode for optimising the display according to the display settings.
 - **Dynamic:** Use this mode to make the display tone more vivid.
 - **Standard:** Use this mode for normal surroundings.
 - **Movie:** Use this mode for dim surroundings, such as in a dark room.
- **Reading mode:** Select which applications will use reading mode. In reading mode, the device helps protect your eyes when reading at night.

- **Brightness:** Set the brightness of the display.
- **Screen timeout:** Set the length of time the device waits before turning off the display's backlight.
- **Daydream:** Set the device to launch a screensaver when your device is connected to a desktop dock or charging.
- **Smart screen:**
 - **Smart stay:** Set the device to prevent the display backlight from turning off while you are looking at the display.
 - **Smart rotation:** Set the interface not to rotate according to the orientation of your face.
- **Font style:** Change the font type for display text.
- **Font size:** Change the font size.
- **Increase legibility:** Sharpen the text to make it easier to read.
- **Touch key light duration:** Set the duration for the touch button backlight.
- **Display battery percentage:** Set the device to display the remaining battery life.

Storage

View memory information for your device and memory card, or format a memory card.



Formatting a memory card permanently deletes all data from it.



The actual available capacity of the internal memory is less than the specified capacity because the operating system and default applications occupy part of the memory.

Power saving mode

Activate power-saving mode and change the settings for power-saving mode.

- **CPU power saving:** Set the device to limit some system resource usage.
- **Screen power saving:** Set the device to decrease the brightness of the display.
- **Learn about Power saving mode:** Discover how to reduce battery consumption.

Battery

View the amount of battery power consumed by your device.

Application manager

View and manage the applications on your device.

Location services

Change settings for location information permissions.

- **Access to my location:** Set the device to allow applications to use your current location information.
- **Use GPS satellites:** Set the device to use the GPS satellite for finding the current location.
- **Use wireless networks:** Set the device to allow location data collection or to determine the location of your lost or stolen device via Wi-Fi.
- **My places:** Set up profiles that will be used for specific locations when you use GPS, Wi-Fi, or Bluetooth features to find your current location.

Lock screen

Change settings for the locked screen.

- **Screen lock:** Activate the screen lock feature. The following options may vary depending on the screen lock feature selected.
- **Multiple widgets:** Set the device to allow use of widgets on the locked screen.
- **Lock screen widgets:**
 - **Clock or personal message:** Set the device to show a clock or personal message on the locked screen. The following options may vary, depending on your selection.

For a clock:

- **Clock size:** Change the size of the clock.
- **Show date:** Set the device to show the date with the clock.
- **Owner information:** Enter your information that is shown with the clock.

For a personal message:

- **Edit personal message:** Edit the personal message.
- **Shortcuts:** Set the device to show and edit application shortcuts on the locked screen.



This feature may not be available depending on the region or service provider.

- **Unlock effect:** Select an effect when you unlock the screen.
- **Help text:** Set the device to show the help text on the locked screen.
- **Wake up in lock screen:** Set the device to recognise your wake up command when the screen is locked.
- **Set wake-up command:** Set a wake up command to launch **S Voice** or perform a specified function.

Security

Change settings for securing the device.

- **Encrypt device:** Set a password to encrypt data saved on the device. You must enter the password each time you turn on the device.



Charge the battery before enabling this setting because it may take more than an hour to encrypt your data.

- **Encrypt external SD card:** Set the device to encrypt files on a memory card.



If you reset your device to the factory defaults with this setting enabled, the device will not be able to read your encrypted files. Disable this setting before resetting the device.

- **Remote controls:** Set the device to allow control of your lost or stolen device remotely via the Internet. To use this feature, you must sign in to your Samsung account.
 - **Account registration:** Add or view your Samsung account.
 - **Use wireless networks:** Set the device to allow location data collection or to determine the location of your lost or stolen device via Wi-Fi.
- **Find my mobile web page:** Access the Find my mobile website (findmymobile.samsung.com). You can track and control your lost or stolen device on the Find my mobile website.
- **Make passwords visible:** By default, the device hides passwords for security. Set the device to display passwords as they are entered.
- **Device administrators:** View device administrators installed on the device. You can allow device administrators to apply new policies to the device.
- **Unknown sources:** Choose to install applications from any source. If not chosen, download applications only from **Play Store**.
- **Verify apps:** Set this to allow Google to check the application for harmful behaviour before installing it.
- **Trusted credentials:** Use certificates and credentials to ensure secure use of various applications.
- **Install from device storage:** Install encrypted certificates stored on the USB storage.
- **Clear credentials:** Erase the credential contents from the device and reset the password.

Language and input

Change the settings for text input. Some options may not be available depending on the selected language.

Language

Select a display language for all menus and applications.

Default

Select a default keyboard type for text input.

Google voice typing

To change the voice input settings, tap .

- **Choose input languages:** Select input languages for text input.
- **Block offensive words:** Set the device to prevent the device from recognising offensive words in voice inputs.
- **Download offline speech recognition:** Download and install language data for offline voice input.

Samsung keyboard

To change the Samsung keyboard settings, tap .



The available options may vary depending on the region or service provider.

- **Input languages:** Select languages for text input.
- **Predictive text:** Activate predictive text mode to predict words based on your input and show word suggestions. You can also customise the word prediction settings.
- **Continuous input:** Set the device to enter text by sweeping on the keyboard.
- **Cursor control:** Enable or disable the smart keyboard navigation feature to move the cursor by scrolling the keyboard.

- **Handwriting:** Customise settings for handwriting mode, such as recognition time, pen thickness, or pen colour.
- **Advanced:**
 - **Auto capitalisation:** Set the device to automatically capitalise the first character after a final punctuation mark, such as a full stop, question mark, or exclamation mark.
 - **Auto spacing:** Set the device to automatically insert a space between words.
 - **Auto-punctuate:** Set the device to insert a full stop when you double-tap the space bar.
 - **Character preview:** Set the device to display a large image of each character tapped.
 - **Key-tap sound:** Set the device to sound when a key is touched.
- **Help:** Access help information for using the Samsung keyboard.
- **Reset settings:** Reset Samsung keyboard settings.

Voice recogniser

Select a voice recognition engine.



This feature appears once you use a voice recognition application.

Voice search

For Samsung voice recognition, use the following options:

- **Language:** Select a language for the voice recognition.
- **Open via the home key:** Set the device to launch **S Voice** by pressing the Home button twice.
- **Use location data:** Set the device to use location information for voice search results.
- **Hide offensive words:** Hide offensive words from voice search results.
- **Help:** Access help information for **S Voice**.
- **About:** View version information.
- **Voice control:** Control applications by voice commands.

- **Wake up command:** Set the device to start voice recognition by saying a wake up command while using **S Voice**.
- **Wake up in lock screen:** Set the device to recognise your wake up command when the screen is locked.
- **Set wake-up command:** Set a wake up command to launch **S Voice** or perform a specified function.
- **Check missed events:** Set the device to check messages, or events when **S Voice** is launched by pressing the headset button.
- **Home address:** Enter your home address to use location information with the voice command feature.
- **Log in to Facebook:** Enter your Facebook account information to use Facebook with **S Voice**.
- **Log in to Twitter:** Enter your Twitter account information to use Twitter with **S Voice**.

For Google voice recognition, use the following options:

- **Language:** Select a language for the voice recognition.
- **Speech output:** Set the device to provide voice feedback to alert you to the current action.
- **Block offensive words:** Hide offensive words from voice search results.
- **Download offline speech recognition:** Download and install language data for offline voice input.
- **Bluetooth headset:** Set the device to allow a voice search with a Bluetooth headset, when it is connected to the device.

Text-to-speech options

- **Preferred TTS engine:** Select a speech synthesis engine. To change the settings for speech synthesis engines, tap .
- **Speech rate:** Select a speed for the text-to-speech feature.
- **Listen to an example:** Listen to the spoken text for an example.

Pointer speed

Adjust the pointer speed for the mouse or trackpad connected to your device.

Cloud

Change settings for syncing data or files with your Samsung account or Dropbox cloud storage.

Backup and reset

Change the settings for managing settings and data.

- **Back up my data:** Set the device to back up settings and application data to the Google server.
- **Backup account:** Set up or edit your Google backup account.
- **Automatic restore:** Set the device to restore settings and application data when the applications are reinstalled on the device.
- **Factory data reset:** Reset settings to the factory default values and delete all data.

Add account

Add email or SNS accounts.

Motion

Activate the motion recognition feature and change the settings that control motion recognition on your device.

- **Palm swipe to capture:** Set the device to capture an image of the screen when you sweep your hand to the left or right across the screen.
- **Palm touch to mute/pause:** Set the device to pause media playback when you touch the screen with your palm.
- **Learn about hand motions:** View the tutorial for controlling hand motions.

Voice control

Change settings to control options by voice commands.

Accessory

Change the accessory settings.

- **Dock sound:** Set the device to play a sound when your device is connected to or removed from a desktop dock.
- **Audio output mode:** Set the device to use the dock speaker when your device is connected to a desktop dock.
- **Audio output:** Select a sound output format to use when connecting your device to HDMI devices. Some devices may not support the surround sound setting.

Date and time

Access and alter the following settings to control how the device displays the time and date.



If the battery remains fully discharged or removed from the device, the time and date is reset.

- **Set date:** Set the current date manually.
- **Set time:** Set the current time manually.
- **Select time zone:** Set the home time zone.
- **Use 24-hour format:** Display time in 24-hour format.
- **Select date format:** Select a date format.

Accessibility

Accessibility services are special features for those with certain physical disabilities. Access and alert the following settings to improve accessibility to the device.

- **Auto-rotate screen:** Set the interface to rotate automatically when you rotate the device.
- **Screen timeout:** Set the length of time the device waits before turning off the display's backlight.
- **Speak passwords:** Set the device to read aloud passwords you enter with Talkback.
- **Show shortcut:** Add a shortcut to **Accessibility** on the quick menu that appears when you press and hold the Power button.
- **Manage accessibility:** Export or import the accessibility settings to share them with other devices.
- **TalkBack:** Activate Talkback, which provides voice feedback.
- **Font size:** Change the font size.
- **Magnification gestures:** Set the device to zoom in and out with finger gestures.
- **Negative colours:** Reverse the display colours to improve visibility.
- **Colour adjustment:** Adjust the colour scheme for the screen when the device determines that you are colour blind or having difficulty reading content.
- **Accessibility shortcut:** Set the device to activate Talkback when you press and hold the Power button, and then tap and hold the screen with two fingers.
- **Text-to-speech options:**
 - **Preferred TTS engine:** Select a speech synthesis engine. To change the settings for speech synthesis engines, tap .
 - **Speech rate:** Select a speed for the text-to-speech feature.
 - **Listen to an example:** Listen to the spoken text for an example.
- **Enhance web accessibility:** Set applications to install web scripts to make their web content more accessible.
- **Sound balance:** Adjust the sound balance when using a dual headset.

- **Mono audio:** Enable mono sound when listening to audio with one earbud.
- **Turn off all sounds:** Mute all device sounds.
- **Assistant menu:** Set the device to show the assistive shortcut icon that helps you access functions supported by external buttons or features on the notifications panel. You can also edit the menu on the shortcut icon.
- **Tap and hold delay:** Set the recognition time for tapping and holding the screen.
- **Interaction control:** Set an area of the screen to be excluded from touch inputs.

About device

Access device information and update device software.

Google Settings

Use this application to configure settings for some features provided by Google.

Tap **Google Settings** on the Applications screen.

Troubleshooting

When you turn on your device or while you are using the device, it prompts you to enter one of the following codes:

Password: When the device lock feature is enabled, you must enter the password you set for the device.

Your device displays network or service error messages

- When you are in areas with weak signals or poor reception, you may lose reception. Move to another area and try again.
- You cannot access some options without a subscription. Contact your service provider for more details.

The touch screen responds slowly or improperly

If your device has a touch screen and the touch screen is not responding properly, try the following:

- Remove any protective covers from the touch screen. Protective covers may prevent the device from recognising your inputs and are not recommended for touch screen devices.
- Ensure that your hands are clean and dry when tapping the touch screen.
- Restart your device to clear any temporary software bugs.
- Ensure that your device software is upgraded to the latest version.
- If the touch screen is scratched or damaged, take it to your local Samsung Service Centre.

Your device freezes or has fatal errors

If your device freezes or hangs, you may need to close programs or reset the device to regain functionality. If your device is frozen and unresponsive, press and hold the Power button for 8-10 seconds. The device reboots automatically.

If this does not solve the problem, perform a factory data reset. On the Applications screen, tap **Settings** → **Backup and reset** → **Factory data reset** → **Reset device** → **Erase everything**.

The device beeps and the battery icon is empty

Your battery is low. Recharge or replace the battery to continue using the device.

The battery does not charge properly or the device turns off

The battery in the device is not user replaceable. If you have problems with the battery or need it replaced, take the device to a Samsung Service Centre.

Your device is hot to the touch

When you use applications that require more power or use applications on your device for an extended period of time, your device may feel hot to the touch. This is normal and should not affect your device's lifespan or performance.

Error messages appear when launching the camera

Your Samsung device must have sufficient available memory and battery power to operate the camera application. If you receive error messages when launching the camera, try the following:

- Charge the battery or replace it with a battery that is fully charged.
- Free some memory by transferring files to a computer or deleting files from your device.
- Restart the device. If you are still having trouble with the camera application after trying these tips, contact a Samsung Service Centre.

Error messages appear when opening music files

Some music files may not play on your Samsung device for a variety of reasons. If you receive error messages when opening music files on your device, try the following:

- Free some memory by transferring files to a computer or deleting files from your device.
- Ensure that the music file is not Digital Rights Management (DRM)-protected. If the file is DRM-protected, ensure that you have the appropriate licence or key to play the file.
- Ensure that your device supports the file type.

Another Bluetooth device is not located

- Ensure that the Bluetooth wireless feature is activated on your device.
- Ensure that the Bluetooth wireless feature is activated on the device you wish to connect to, if necessary.
- Ensure that your device and the other Bluetooth device are within the maximum Bluetooth range (10 m).

If the tips above do not solve the problem, contact a Samsung Service Centre.

A connection is not established when you connect the device to a computer

- Ensure that the USB cable you are using is compatible with your device.
- Ensure that you have the proper drivers installed and updated on your computer.
- If you are a Windows XP user, ensure that you have Windows XP Service Pack 3 or higher installed on your computer.
- Ensure that you have Samsung Kies 2.0 or Windows Media Player 10 or higher installed on your computer.

A small gap appears around the outside of the device case

- This gap is a necessary manufacturing feature and some minor rocking or vibration of parts may occur.
- Over time, friction between parts may cause this gap to expand slightly.

Some content may differ from your device depending on the region, service provider, or software version, and is subject to change without prior notice.

